



MURATORI

**TIPO-TYPE-TYP
MT 15**

CATALOGO RICAMBI
Catalogue Pièces Detachées
Ersatzteilkatalog
Spare Parts Catalogue
Catálogo Recambios

EDIZIONE 02/2022

Per ordinare parti di ricambio specificare:

- tipo e matricola della macchina (apposti sulla macchina o sui documenti di acquisto);
- numero del riferimento del pezzo nel disegno (Pos.), numero della tavola (Tav.) e numero di codice

N.B.: le indicazioni destro o sinistro vengono date guardando la macchina da dietro.

Pour les commandes de pièces de rechange veuillez spécifier:

- *type et numéro de série de la machine (indiqués sur la machine et sur le bon d'achat);*
- *numéro de référence du pièce sur le plan (Pos.), numéro du plan (Tav.) et numéro de code (codice)*

N.B.: *les indications droite ou gauche sont données en regardant la machine par derrière.*

Zum Bestellen von Ersatzteilen folgendes angeben:

- *Typ und Serien-Nr. der Maschine (zu finden auf der Maschine oder der Einkaufspapieren);*
- *Bezug-Nr. des Ersatzteils auf der Zeichnung (Pos.), Zeichnungsnummer (Tav.) und Kodenummer (codice)*

N.B.: *die Angaben rechts und links verstehen sich so, dass man hinter der Maschine steht.*

When ordering spare parts specify:

- machine type and serial number (found on the machine or on the purchasing documents);
- reference number of the part on the relative drawing (Pos.) number of the drawing (Tav.) and part number (codice)

N.B.: right-hand or left-hand indications are made by viewing the machine from the rear.

TAV. 1.0

GRUPPO TELAIO
 ENSEMBLE CHASSIS
 SATZ FÜR RAHMEN
 KIT FOR FRAME

TAV. 2.0

GRUPPO TRASMISSIONE ROTORE
 ENSEMBLE TRANSMISSION ROTOR
 SATZ FÜR DEN ROTARANTRIEB
 KIT FOR THE ROTOR TRANSMISSION

TAV. 3.0

GRUPPO RULLO POSTERIORE
 ENSEMBLE ROULEAU ARRIERE
 SATZ HINTERE WALZE
 KIT REAR ROLLER

TAV. 4.0

GRUPPO MOLTIPLICATORE
 ENSEMBLE MULTIPLICATEUR
 SATZ FÜR GETRIEBE
 KIT FOR GEAR BOX

TAV. 5.0

ACCESSORI A COMPLETAMENTO
 OPTIONS D'ACHEVEMENT
 ZUBEHÖRE ZUR ERGANZUNG DER MASCHINE
 CHOICE OF EQUIPMENT COMPLETING MACHINE

TAV. 6.0

ACCESSORI A COMPLETAMENTO
 OPTIONS D'ACHEVEMENT
 ZUBEHÖRE ZUR ERGANZUNG DER MASCHINE
 CHOICE OF EQUIPMENT COMPLETING MACHINE

TAV. 7.0

ALBERO CARDANICO COMPLETO - AB207SF
 ARBRE A JOINTS DE CARDAN - AB207SF
 KARDANWELLE - AB207SF
 PTO SHAFT - AB207SF

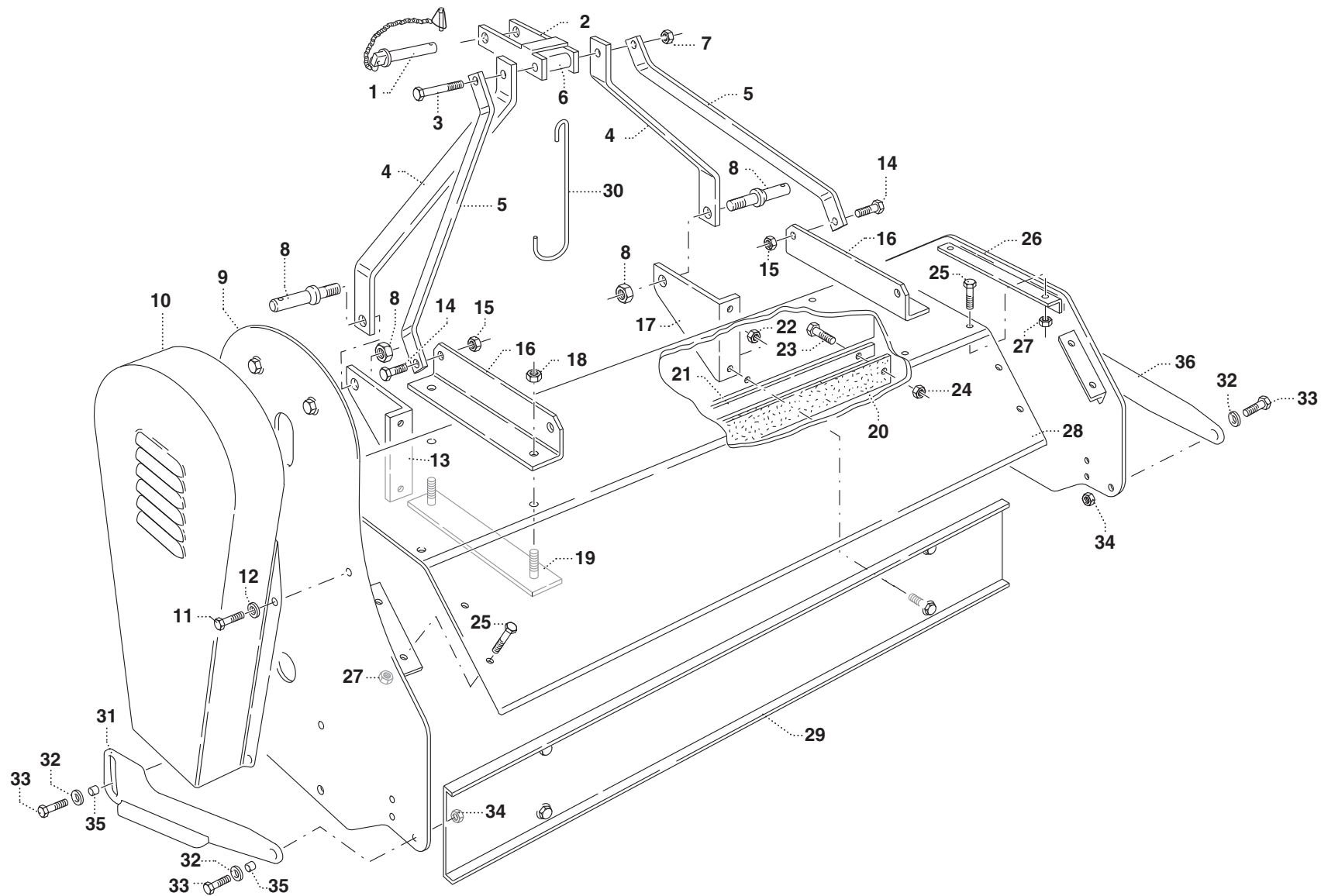

MURATORI MT15

TAV. 1.0

POS.	N° CODICE	Q.	DESCRIZIONE	DESIGNATION	BENENNUNG	DESCRIPTION	DESIGNAZIONE	Da matr. De nr. serie Vom Seriennr. From serial nr.	Fino matr. Jusqu'au nr. serie Bis Seriennr. Up to serial nr.
1	68062000	1	PERNO	PIVOT	BOLZEN	PIN			
2	40237800	1	ATTACCO	ATTACHE	ANSCHLUSS	ATTACHMENT			
3	60033000	1	VITE	VIS	SCHRAUBE	SCREW	TE 12 x 130 UNI 5737		
4	30178800	2	TIRANTE	TIRANT	STANGE	TIEROD			
5	30178900	2	TIRANTE	TIRANT	STANGE	TIEROD			
6	32021400	1	DISTANZIALE	ENTRETOISE	DISTANZSTUECK	SPACER			
7	62010600	1	DADO	ECROU	MUTTER	NUT	M 12 x 1,75 AUTOBLOCC.		
8	68062500	2	PERNO	PIVOT	BOLZEN	PIN			
9	40315900	1	PIASTRA CARTER	PLAQUE	SEITENWAND	SIDE FRAME			
10	40227701	1	COPERCHIO	COUVERCLE	DECKEL	COVER			
11	60022800	4	VITE	VIS	SPINDEL	SCREW	TE 8 x 20 UNI 5739		
12	61006200	4	RONDELLA	RONDELLE	SCHEIBE	WASHER	PIANA Øi 9 Øe24 sp.1,5		
13	39251500	1	STAFFA SX	BRIDE (G)	BUEGEL (LINKS)	BRACKET (LH)			
14	60023000	2	VITE	VIS	SCHRAUBE	SCREW	TE 12 x 30 UNI 5739		
15	62010600	2	DADO	ECROU	MUTTER	NUT	M 12 x 1,75 AUTOBLOCC.		
16	39251700	2	STAFFA	BRIDE	BUEGEL	BRACKET			
17	39251600	1	STAFFA DX	BRIDE (D)	BUEGEL(RECHTS)	BRACKET (RH)			
18	62010600	4	DADO	ECROU	MUTTER	NUT	M 12 x 1,75 AUTOBLOCC.		
19	40231700	2	CONTROFLANGIA	CONTRE-BRIDE	GEGENFLANSCH	COUNTERFLANGE			
20	68067800	1	BANDELLA	BANDE	BAND	STRAP	105		
20	68067900	1	BANDELLA	BANDE	BAND	STRAP	130		
20	68068000	1	BANDELLA	BANDE	BAND	STRAP	155		
21	30125500	1	PIATTO	PLAQUE	PLATTE	DISC	105		
21	30125600	1	PIATTO	PLAQUE	PLATTE	DISC	130		
21	30125700	1	PIATTO	PLAQUE	PLATTE	DISC	155		
22	62010600	4	DADO	ECROU	MUTTER	NUT	M 12 x 1,75 AUTOBLOCC.		

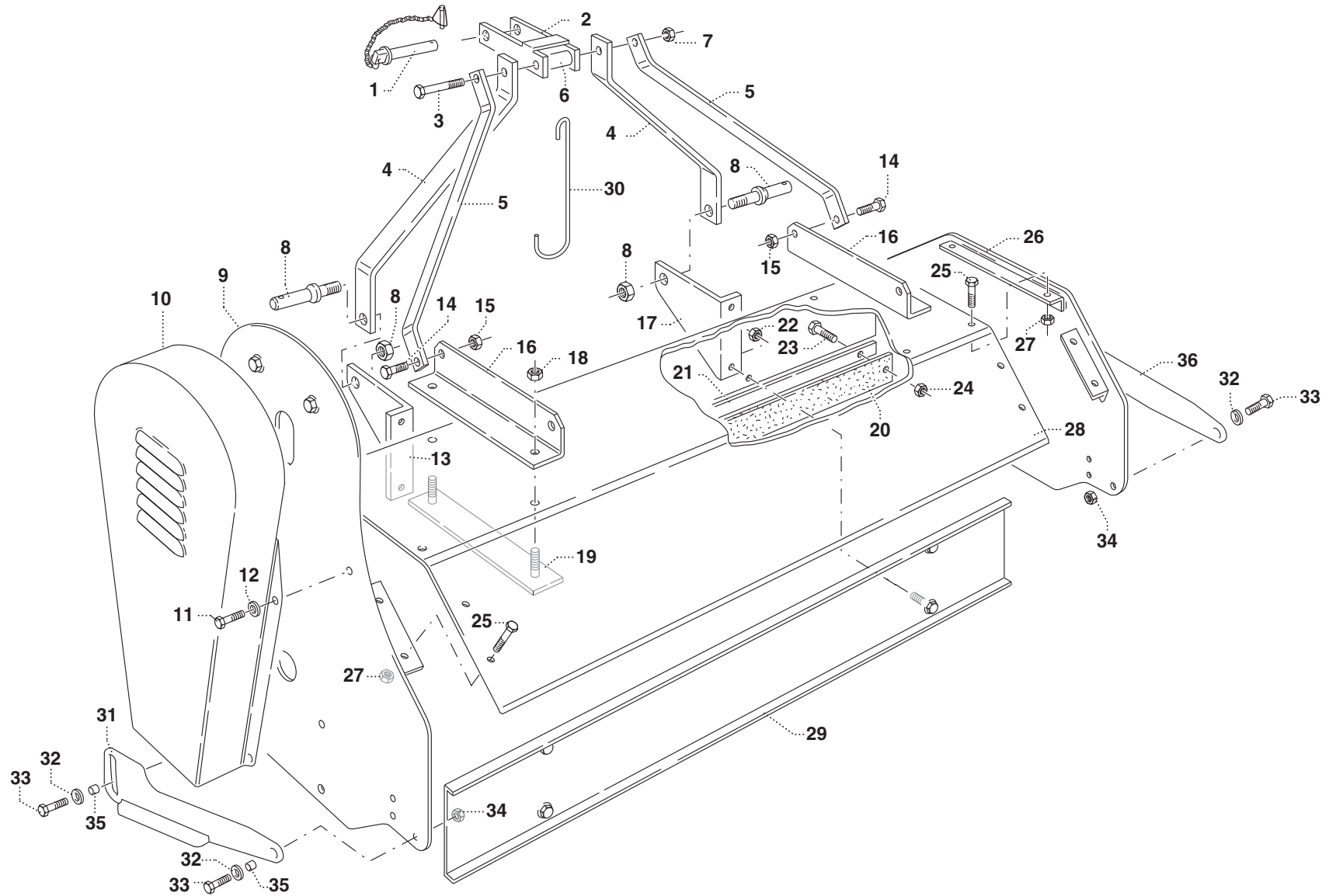

MURATORI MT15

TAV. 2.0

POS.	N° CODICE	Q.	DESCRIZIONE	DESIGNATION	BENENNUNG	DESCRIPTION	DESIGNAZIONE	Da matr. De nr. serie Vom Seriennr. From serial nr.	Fino matr. Jusqu'au nr. serie Bis Seriennr. Up to serial nr.
1	68058900	1	CALETTATORE	DOUILLE DE SERRAGE	SPANNBUCHSE	LOCKING DEVICE	Øi 25 Øe 55		
2	68059000	1	CALETTATORE	DOUILLE DE SERRAGE	SPANNBUCHSE	LOCKING DEVICE	Øi 30 Øe 55		
3	68058800	1	PULEGGIA	POULIE	RIEMENSCHIEBE	PULLEY	Ø 100 2 SPA		
4	68082000	2	CINGHIA	COURROIE	KEILRIEMEN	BELT	A 43		
5	68121500	1	PULEGGIA	POULIE	RIEMENSCHIEBE	PULLEY	Ø 170 2 SPA		
6	67012600	1	SUPPORTO	SUPPORT	HALTERUNG	SUPPORT	UCP 205		
7	39253600	1	REGOLAZIONE	REGULATEUR	MECHANISCHER REGLER	GOVERNOR			
8	40265801	1	PROTEZIONE	PROTECTION	SCHUTZ	GUARD	105		
8	40265901	1	PROTEZIONE	PROTECTION	SCHUTZ	GUARD	130		
8	40266001	1	PROTEZIONE	PROTECTION	SCHUTZ	GUARD	155		
9	60027000	2	VITE	VIS	SCHRAUBE	SCREW	TE 12 x 70 UNI 5737		
10	61000900	2	RONDELLA	RONDELLE	SCHEIBE	WASHER	PIANA Ø12 UNI 6592		
11	60023000	2	VITE	VIS	SCHRAUBE	SCREW	TE 12 x 30 UNI 5739		
12	32171000	1	SPESSORE	EPAISSEUR	DISTANZRING	SPACER			
13	61004700	2	RONDELLA	RONDELLE	SCHEIBE	WASHER	PIANA Ø8 UNI 6592		
14	68074300	1	PROTEZIONE	PROTECTION	SCHUTZ	GUARD			
15	60015100	2	VITE	VIS	SCHRAUBE	SCREW	TE 8 x 16 UNI 5739		
16	30212500	1	SPESSORE	EPAISSEUR	DISTANZRING	SPACER			
17	62010600	2	DADO	ECROU	MUTTER	NUT	M 12 x 1,75 AUTOBLOCC.		
18	30175300	1	PIATTO BLOCCAGGIO	PLAQUE	PLATTE	DISC			
19	60023000	2	VITE	VIS	SCHRAUBE	SCREW	TE 12 x 30 UNI 5739		
20	39333500	1	SOSTEGNO	SUPPORT	TRAEGER	SUPPORT			
21	40316100	1	SUPPORTO	SUPPORT	HALTERUNG	SUPPORT			
22	60021600	4	VITE	VIS	SCHRAUBE	SCREW	TE 10 x 20 UNI 5739		
23	40231800	1	PIATTO	PLAQUE	PLATTE	DISC			
24	40228501	1	PROLUNGA	RALLONGE	VERLAENGERUNGSROHR	EXTENSION	105		

MURATORI MT15

TAV. 2.0

POS.	N° CODICE	Q.	DESCRIZIONE	DESIGNATION	BENENNUNG	DESCRIPTION	DESIGNAZIONE	Da matr. De nr. serie Vom Seriennr. From serial nr.	Fino matr. Jusqu'au nr. serie Bis Seriennr. Up to serial nr.
24	40228601	1	PROLUNGA	RALLONGE	VERLAENGERUNGSROHR	EXTENSION	130		
24	40228701	1	PROLUNGA	RALLONGE	VERLAENGERUNGSROHR	EXTENSION	155		
25	62010600	2	DADO	ECROU	MUTTER	NUT	M 12 x 1,75 AUTOBLOCC.		
26	65001100	1	LINGUETTA	CLAVETTE	FEDER	KEY	8 x 7 x 30		
27	60035500	1	VITE	VIS	SCHRAUBE	SCREW	TE 12 x 50 UNI 5739		
28	62000600	1	DADO	ECROU	MUTTER	NUT	M 12 x 1,75 UNI 5587		
29	66014000	1	ANELLO TENUTA	JOINT D'ETANCHEITE	DICHTUNGSRING	JUNT RING	30 x 40 x 4		
30	64000200	2	INGRASSATORE	GRAISSEUR	SCHMIERNIPPEL	GREASE FITTING	M6 x 1		
31	40228000	1	SUPPORTO SX	SUPPORT (G)	HALTER (LINKS)	SUPPORT (LH)			
32	32068000	1	SPESSORE	EPAISSEUR	DISTANZRING	SPACER			
33	67012900	2	CUSCINETTO	ROULEMENT	LAGER	BEARING	1306		
34	68068800		SPESSORE	EPAISSEUR	DISTANZRING	SPACER	42 x 30 x 1		
35	39091100	2	DISCO	DISQUE	SCHEIBE	DISC			
36	42045400	1	ROTORE	ROTOR	ROTOR	ROTOR	105		
36	42045500	1	ROTORE	ROTOR	ROTOR	ROTOR	130		
36	42045600	1	ROTORE	ROTOR	ROTOR	ROTOR	155		
37	60012900		VITE	VIS	SCHRAUBE	SCREW	TE 8 x 45 UNI 5737		
38	61006200		RONDELLA	RONDELLE	SCHEIBE	WASHER	PIANA Ø 9		
39	31042800		BOCCOLA	DOUILLE	BUECHSE	BUSHING			
40	12010200		COLTELLO	COUTEAU	MESSER	KNIFE			
41	62010200		DADO	ECROU	MUTTER	NUT	M 8 AUTOBLOCC.		
42	60020400	4	VITE	VIS	SCHRAUBE	SCREW	TE 12 x 25 UNI 5739		
43	62010600	4	DADO	ECROU	MUTTER	NUT	M 12 x 1,75 AUTOBLOCC.		
44	62010800		DADO	ECROU	MUTTER	NUT	M 14 x 2 AUTOBLOCC.		136326
44	62010400		DADO	ECROU	MUTTER	NUT	M 10 x 1,5 AUTOBLOCC.	136327	
45	12015100		COLTELLO A SPATOLE	COUTEAU	MESSER	KNIFE			

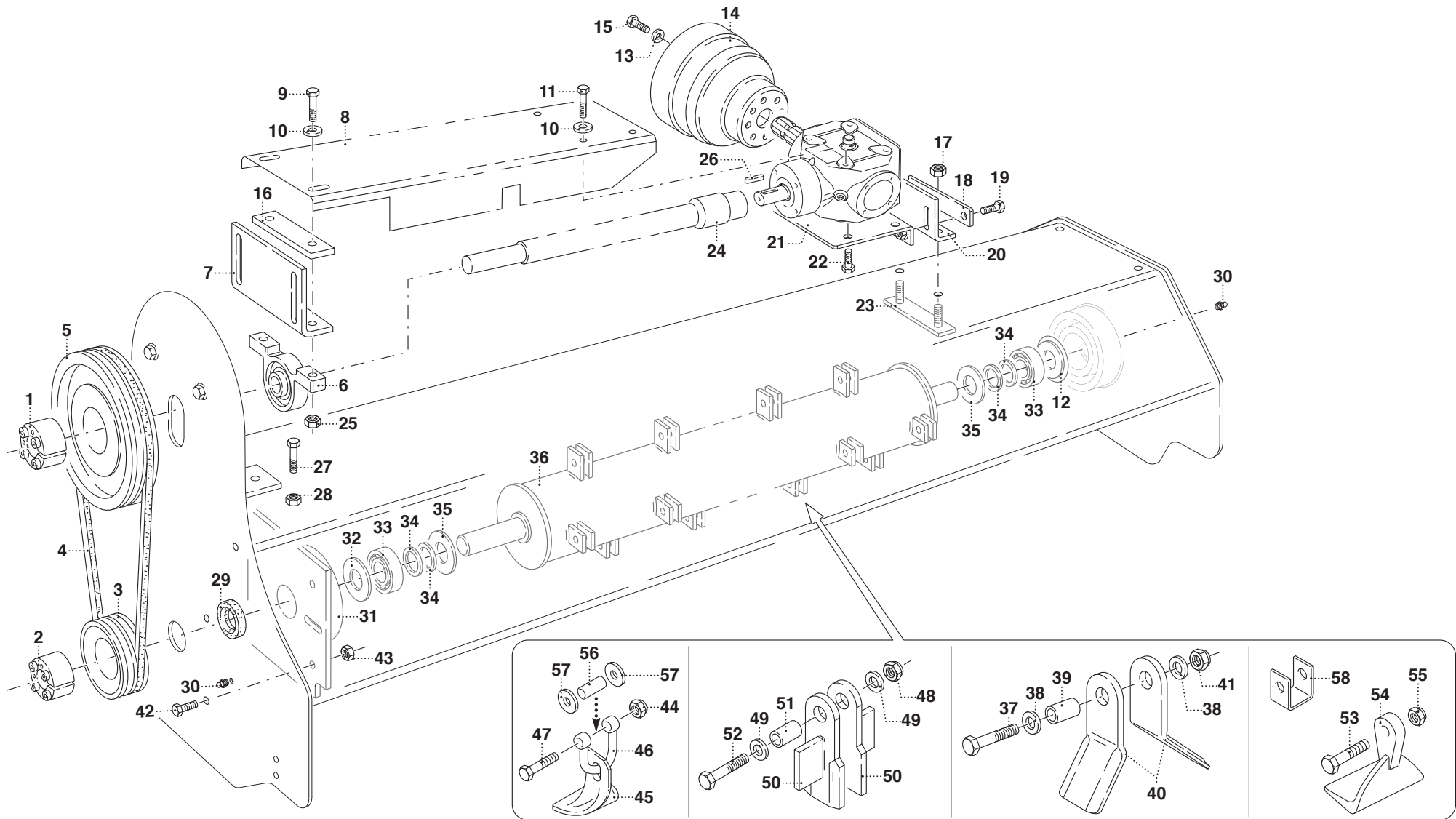

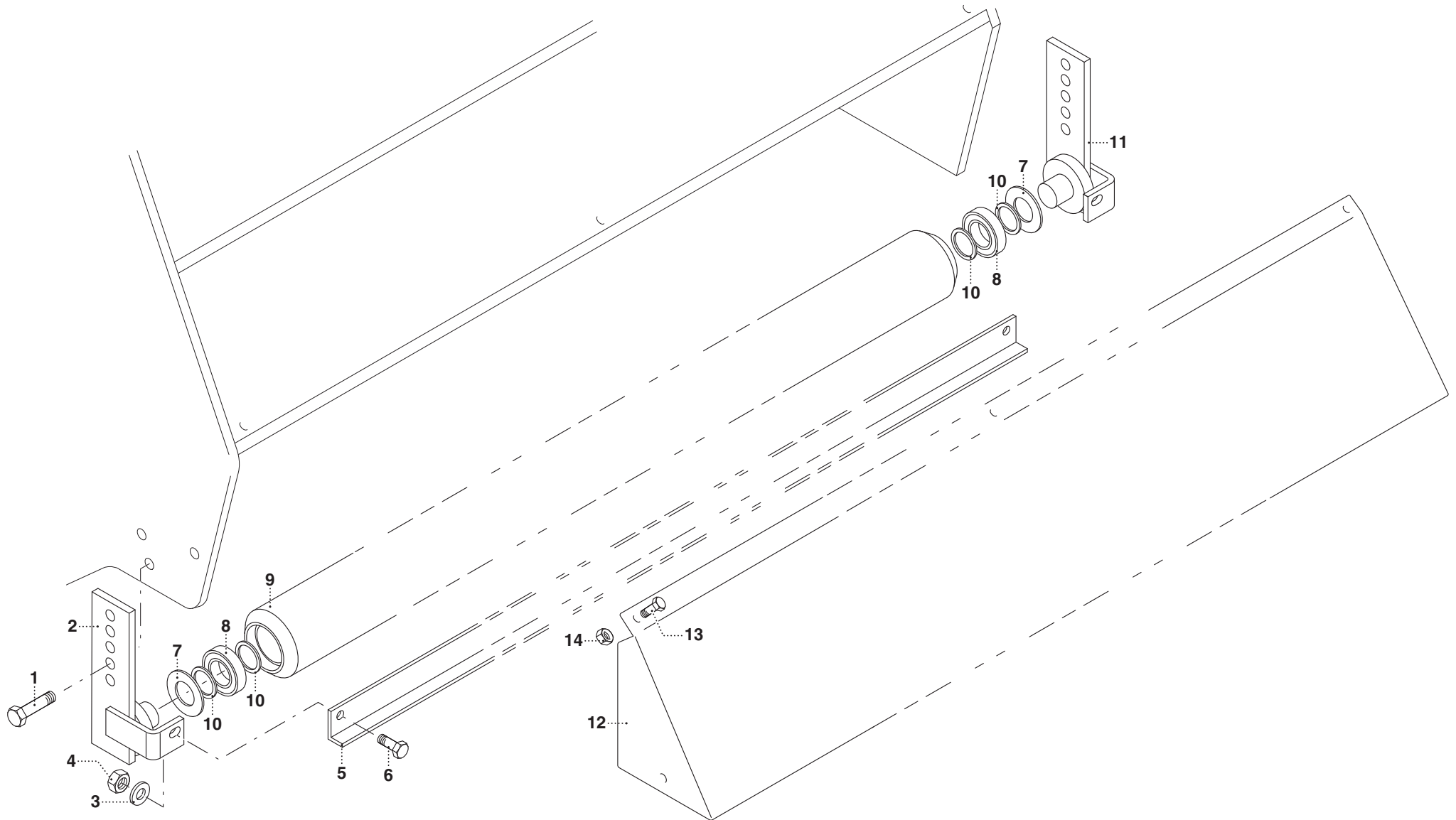

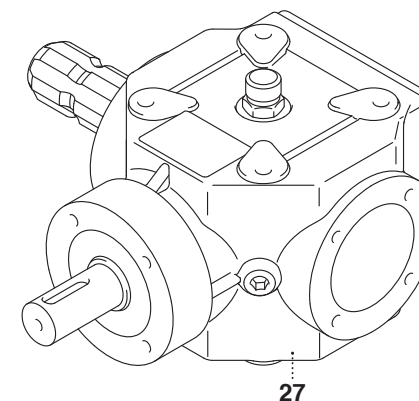
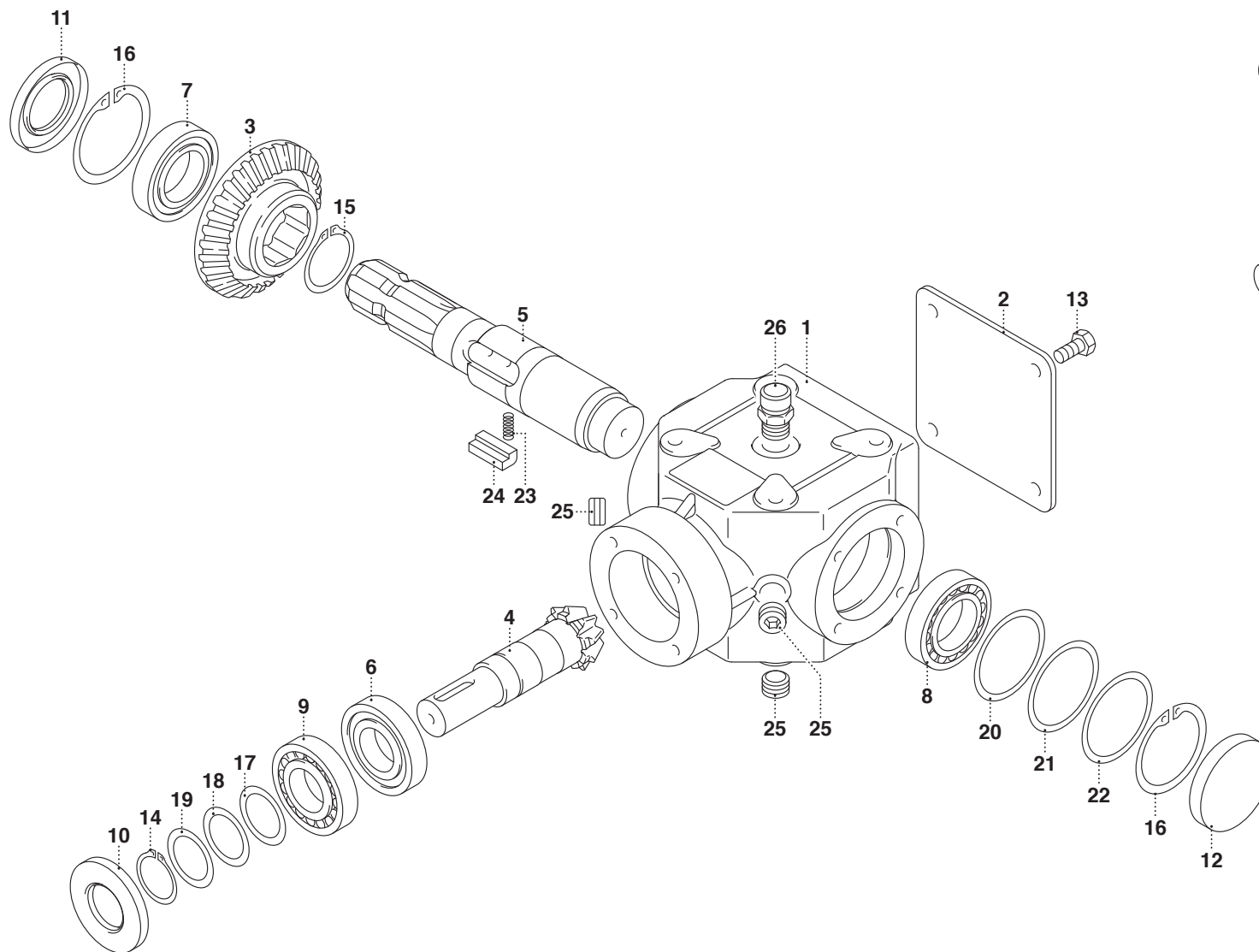

MURATORI MT15

TAV. 4.0

POS.	N° CODICE	Q.	DESCRIZIONE	DESIGNATION	BENENNUNG	DESCRIPTION	DESIGNAZIONE	Da matr. De nr. serie Vom Seriennr. From serial nr.	Fino matr. Jusqu'au nr. serie Bis Seriennr. Up to serial nr.
1	01020400	1	SCATOLA	CARTER	GEHAEUSE	GEARBOX			
2	39340600	1	COPERCHIO	COUVERCLE	DECKEL	COVER			
3	10050900	1	CORONA	COURONNE	KRANZ	CROWN			
4	10051000	1	PIGNONE	PIGNON	RITZEL	PINION			
5	31099200	1	ALBERO	ARBRE	WELLE	SHAFT			
6	67015700	1	CUSCINETTO	ROULEMENT	LAGER	BEARING	30206		
7	67017200	1	CUSCINETTO	ROULEMENT	LAGER	BEARING	30207		
8	67018500	1	CUSCINETTO	ROULEMENT	LAGER	BEARING	6007		
9	67018600	1	CUSCINETTO	ROULEMENT	LAGER	BEARING	6206		
10	66019700	1	ANELLO TENUTA	JOINT D'ETANCHEITE	DICHTUNGSRING	JUNT RING	30 x 62 x 8		
11	66011600	1	ANELLO TENUTA	JOINT D'ETANCHEITE	DICHTUNGSRING	JUNT RING	35 x 62 x 7		
12	68123900	1	CAPPELOTTO	BOUCHON	ABSCHLUSSKAPPE	CAP NUT	62 x 9,5		
13	60015100	4	VITE	VIS	SCHRAUBE	SCREW	TE 8 x 16 UNI 5739		
14	63005700	1	ANELLO ELASTICO	ARRETOIR	SPANNRING	SNAP-RING	Ø30 E UNI 7436		
15	63005000	1	ANELLO ELASTICO	ARRETOIR	SPANNRING	SNAP-RING	Ø42 E UNI 7435		
16	63001700	1	ANELLO ELASTICO	ARRETOIR	SPANNRING	SNAP-RING	Ø62 I UNI 7437		
17	68124000	1	SPESSORE	EPAISSEUR	DISTANZRING	SPACER	30 x 40 x 0,1		
18	68124100	1	SPESSORE	EPAISSEUR	DISTANZRING	SPACER	30 x 40 x 0,5		
19	68124200	1	SPESSORE	EPAISSEUR	DISTANZRING	SPACER	30 x 40 x 1		
20	68039000	1	SPESSORE	EPAISSEUR	DISTANZRING	SPACER	62 x 50 x 0,3		
21	68124300	1	SPESSORE	EPAISSEUR	DISTANZRING	SPACER	62 x 50 x 0,5		
22	68011500	2	SPESSORE	EPAISSEUR	DISTANZRING	SPACER	62 x 50 x 1		
23	68124400	6	MOLLA	RESSORT	FEDER	SPRING			
24	65003500	3	CHIAVETTA	CLAVETTE	KEIL	SPLINE			
25	68124500	3	TAPPO	BOUCHON	STOPFEN	PLUG			
26	68085600	1	TAPPO	BOUCHON	STOPFEN	PLUG			

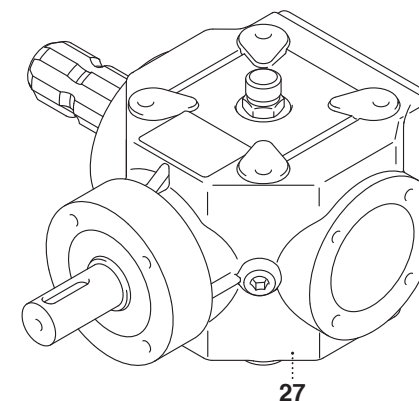
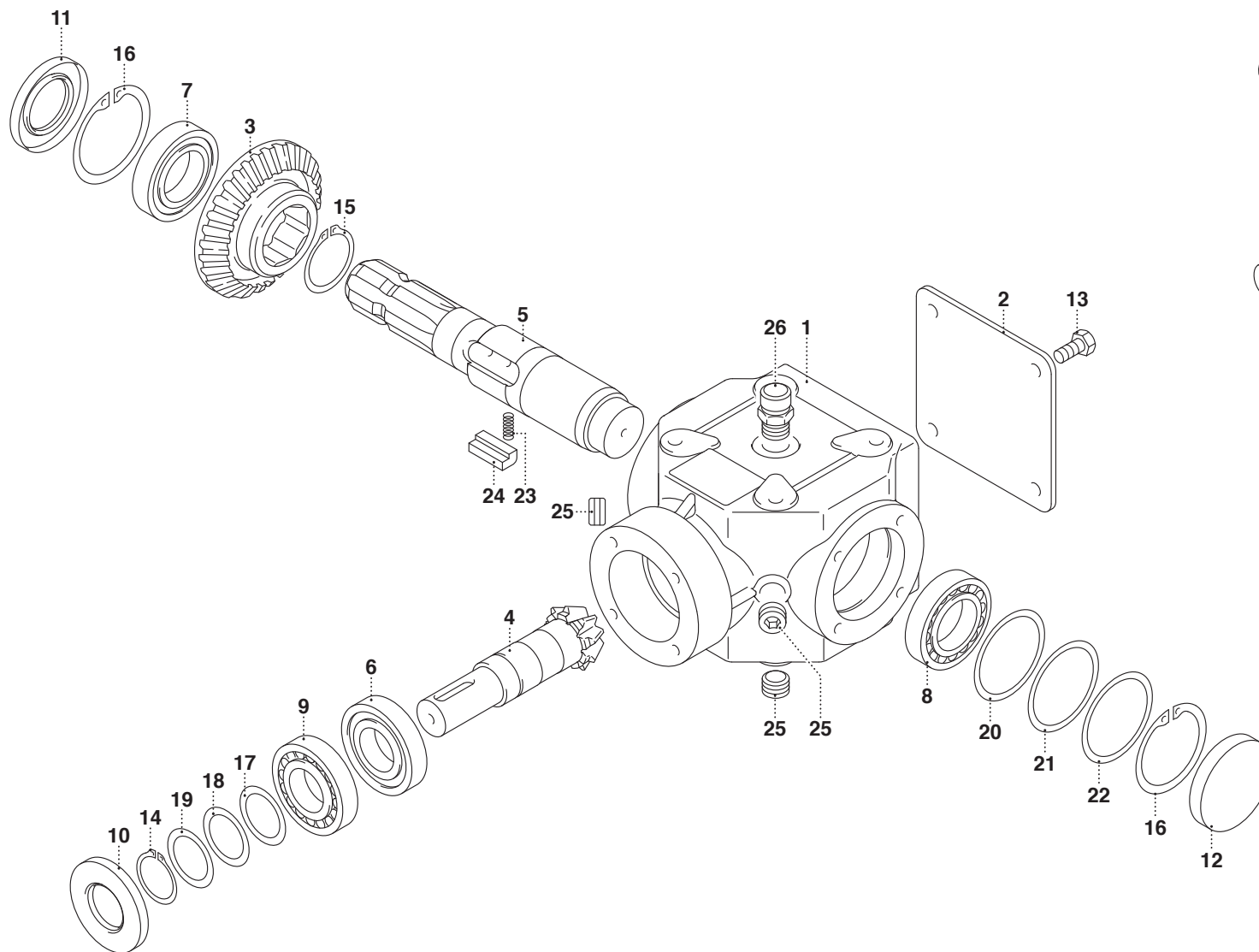

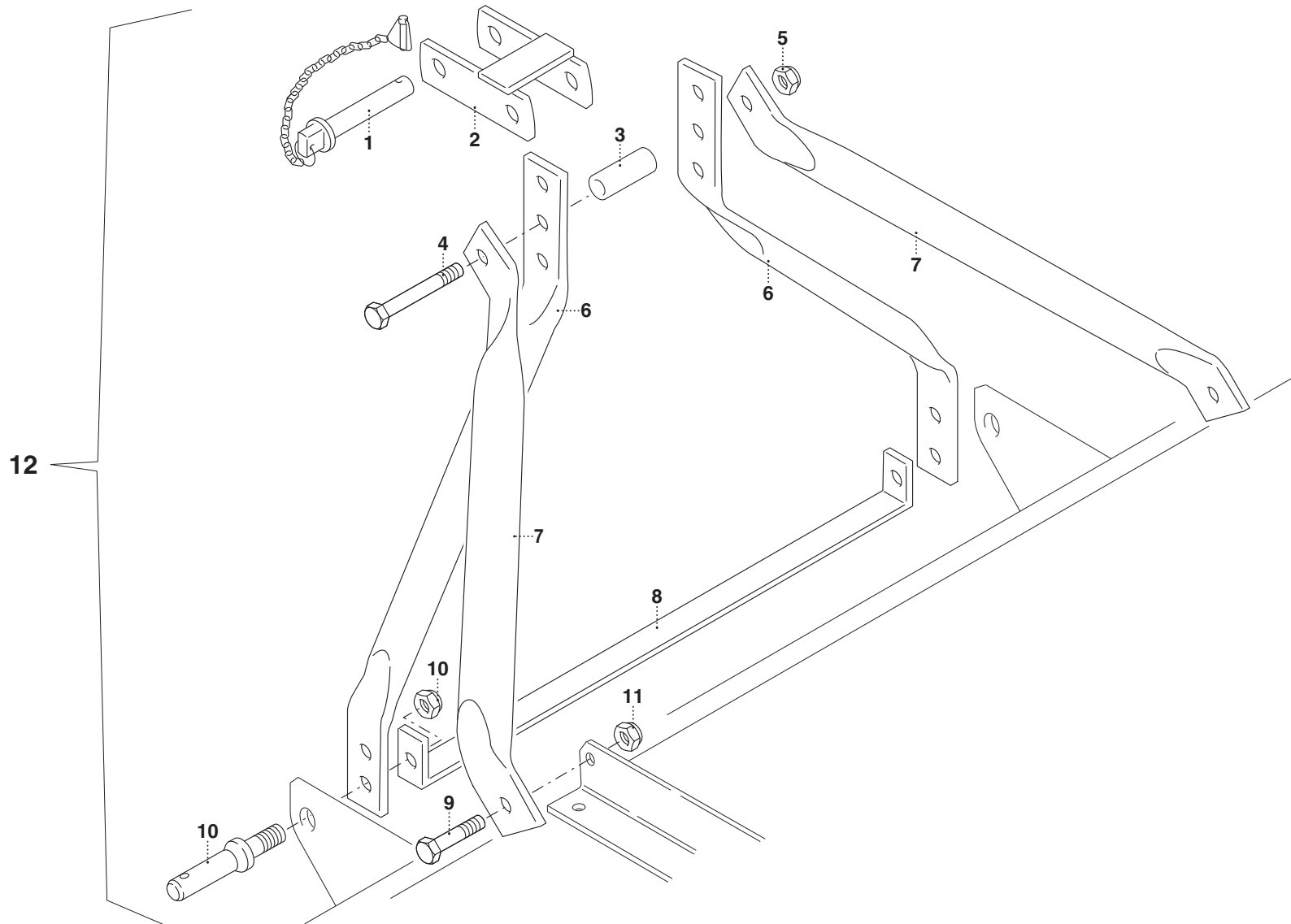

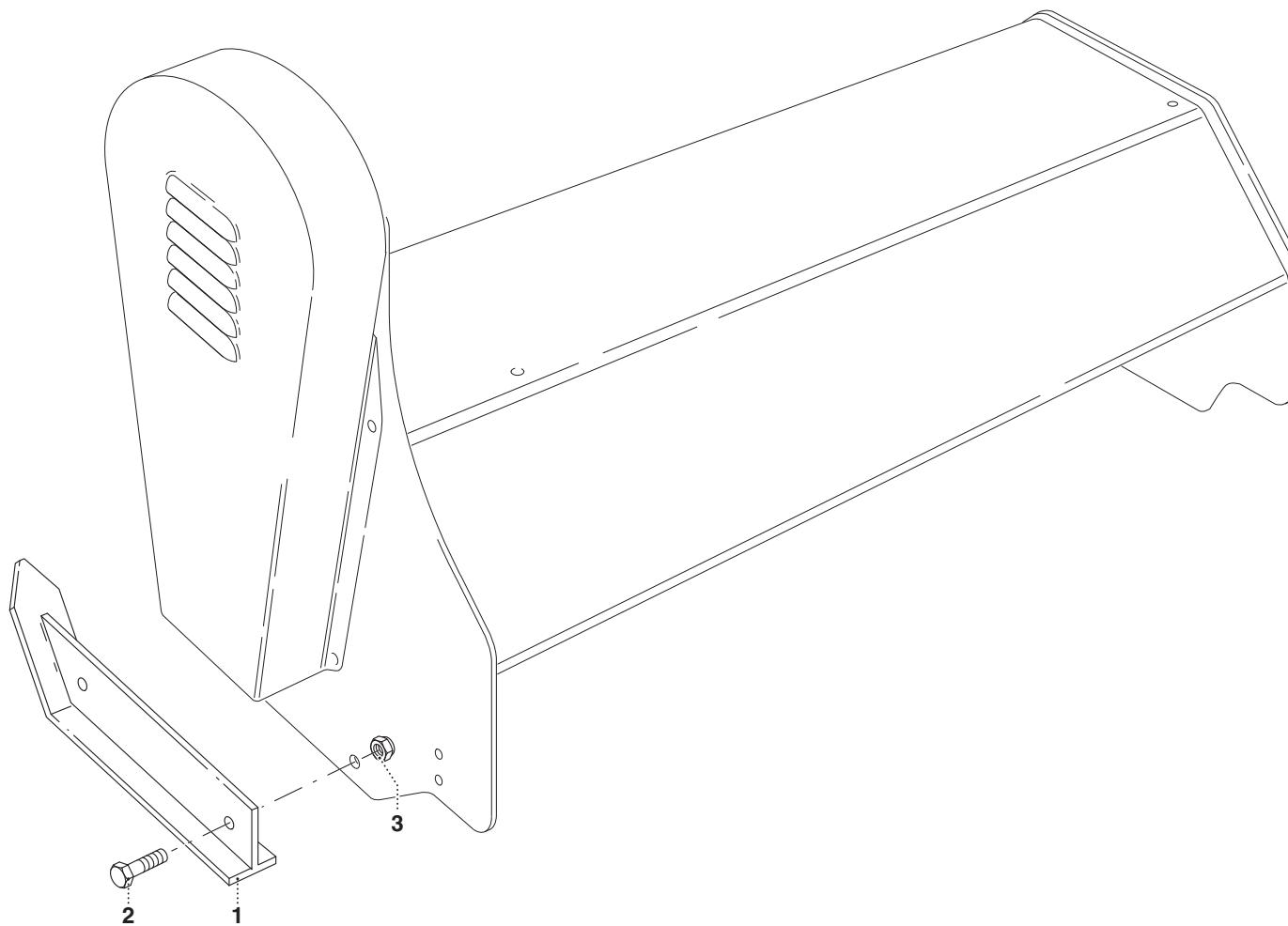

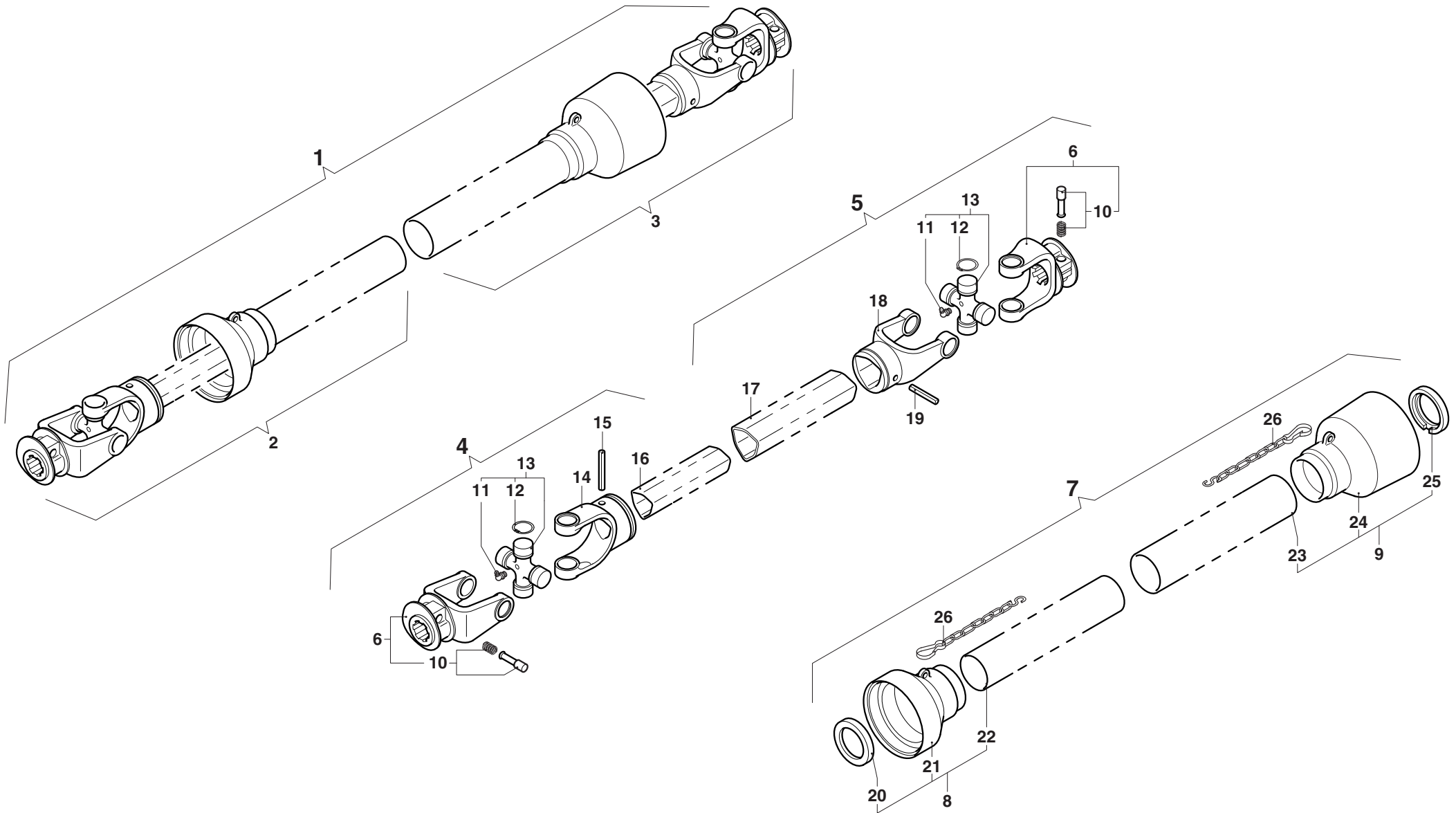

MURATORI MT15

TAV. 7.0

POS.	N° CODICE	Q.	DESCRIZIONE	DESIGNATION	BENENNUNG	DESCRIPTION	DESIGNAZIONE	Da matr.	Fino matr.
								De nr. serie Vom Seriennr. From serial nr.	Jusqu'au nr. serie Bis Seriennr. Up to serial nr.
1	AB207SF	1	ALBERO CARDANICO COMPLETO	ARBRE A JOINTS DE CARDAN	KARDANWELLE	PTO SHAFT			
2	B2070B1	1	SEMIALBERO INTERNO	DEMI-ARBRE INTERIEUR	INNENHALBWELLE	INTERNAL HALF SHAFT			
3	B2070B2	1	SEMIALBERO ESTERNO	DEMI-ARBRE EXTERIEUR	AUSSENHALBWELLE	EXTERNAL HALF SHAFT			
4	B207001	1	SEMIALBERO INTERNO	DEMI-ARBRE INTERIEUR	INNENHALBWELLE	INTERNAL HALF SHAFT			
5	B2070002	1	SEMIALBERO ESTERNO	DEMI-ARBRE EXTERIEUR	AUSSENHALBWELLE	EXTERNAL HALF SHAFT			
6	0800203	2	FORCELLA	FOURCHE	GABEL	YOKE			
7	083B02070	1	PROTEZIONE	PROTECTION	SCHUTZ	GUARD			
8	083B020701	1	PROTEZIONE INTERNA	PROTECTION INTERIEURE	INNENSCHUTZ	INTERNAL GUARD			
9	083B020702	1	PROTEZIONE ESTERNA	PROTECTION EXTERIEURE	AUSSENSCHUTZ	EXTERNAL GUARD			
10	0986014047	2	PULSANTE	BOUTON	DRUCKKNOPF	PUSH BOTTON			
11	09840081002	2	INGRASSATORE	GRAISSEUR	SCHMIERNIPPEL	GREASE FITTING			
12	098020224	8	ANELLO ELASTICO	ARRETOIR	SPANNRING	SNAP-RING			
13	08202	2	CROCIERA	CROISILLON	KREUZSTUECK	SPIDER			
14	08002011	1	FORCELLA	FOURCHE	GABEL	YOKE			
15	098700850	1	SPINA ELASTICA	GOUPILLE ELASTIQUE	SPANNSTIFT	ELASTIC PIN			
16	09881294100	1	TUBO INTERNO	TUBE INTERIEUR	INNENROHR	INTERNAL TUBE			
17	09881363100	1	TUBO ESTERNO	TUBE EXTERIEUR	AUSSENROHR	EXTERNAL TUBE			
18	08002021	1	FORCELLA	FOURCHE	GABEL	YOKE			
19	098700855	1	SPINA ELASTICA	GOUPILLE ELASTIQUE	SPANNSTIFT	ELASTIC PIN			
20	0265220008	1	GHIERA	FRETTE	NUTMUTTER	RING NUT			
21	0256010425	1	CUFFIA	CAPOUCHON	HAUBE	GUARD			
22	0988955B2070	1	TUBO INTERNO	TUBE INTERIEUR	INNENROHR	INTERNAL TUBE			
23	0988961B2070	1	TUBO ESTERNO	TUBE EXTERIEUR	AUSSENROHR	EXTERNAL TUBE			
24	0256010424	1	CUFFIA	CAPOUCHON	HAUBE	GUARD			
25	0265220007	1	GHIERA	FRETTE	NUTMUTTER	RING NUT			

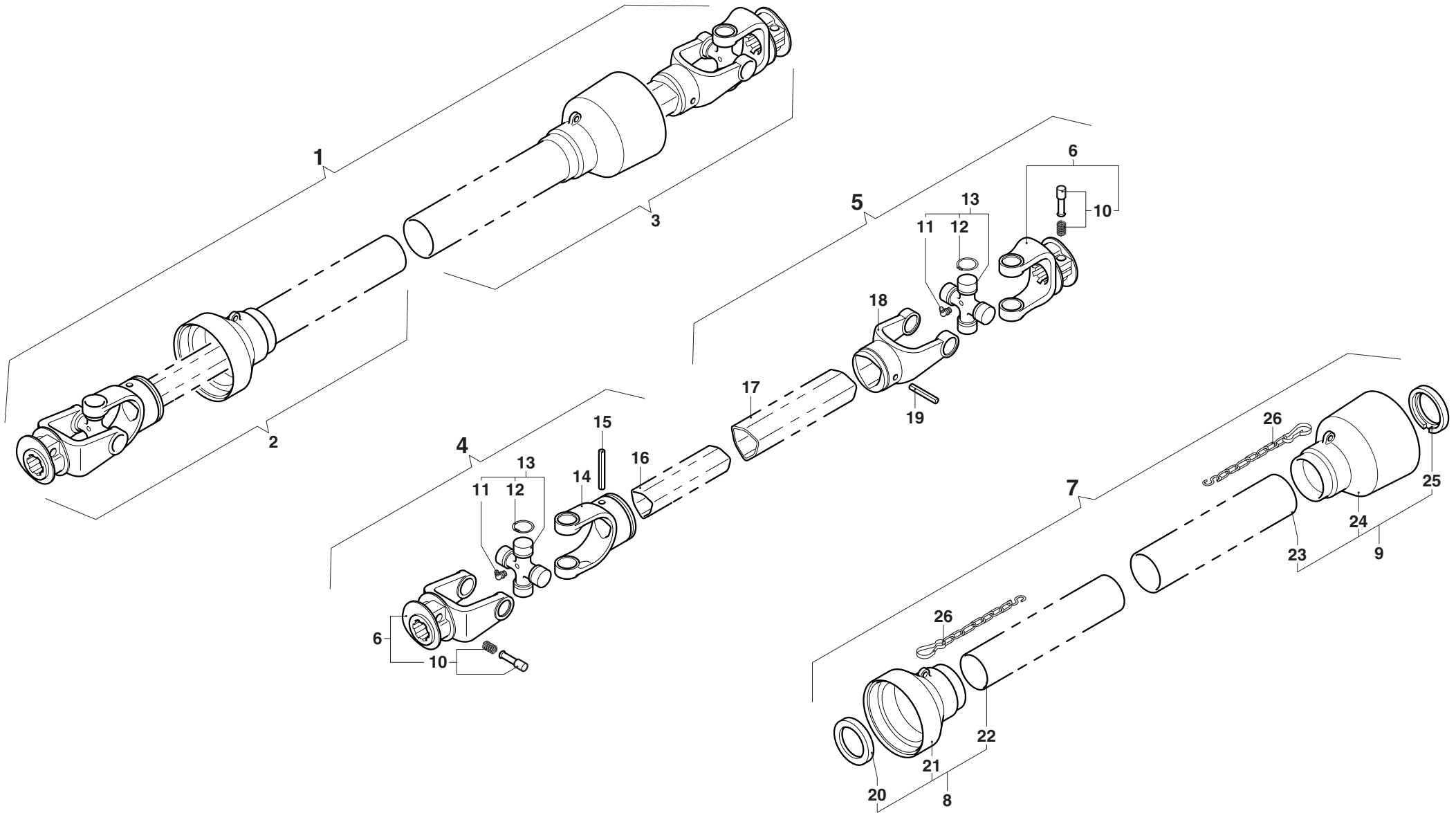



MURATORI S.p.A.

Via Pavarello, 21 - 41051 Castelnuovo Rangone (MO) Italy - Tel. 059.5330611 Fax 059.537259

www.muratoriequip.it *info@muratoriequip.it*

Capitale sociale Euro 480.000 interamente versato

Registro Imprese di Modena

Codice fiscale e numero d'iscrizione: 00708860366