



MURATORI

**TIPO-TYPE-TYP
MT 30 R**

CATALOGO RICAMBI
Catalogue Pièces Detachées
Ersatzteilkatalog
Spare Parts Catalogue
Catálogo Recambios

EDIZIONE 05/2018



**NORME PER LE ORDINAZIONI - COMMANDES/NORMES - BESTELLNORMEN - HOW TO ORDER
INDICE DELLE TAVOLE - INDEX DES TABLES - TAFELVERZEICHNIS - TABLES INDEX**

MT 30 R

Per ordinare parti di ricambio specificare:

- tipo e matricola della macchina (apposti sulla macchina o sui documenti di acquisto);
- numero del riferimento del pezzo nel disegno (Pos.), numero della tavola (Tav.) e numero di codice

N.B.: le indicazioni destro o sinistro vengono date guardando la macchina da dietro.

Pour les commandes de pièces de rechange veuillez spécifier:

- *type et numéro de serie de la machine (indiqués sur la machine et sur le bon d'achat);*
- *numéro de référence du pièce sur le plan (Pos.), numéro du plan (Tav.) et numero de code (codice)*

N.B.: *les indications droite ou gauche sont données en regardant la machine par derrière.*

Zum Bestellen von Ersatzteilen folgendes angeben:

- Typ und Serien-Nr. der Maschine (zu finden auf der Maschine oder der Einkaufspapieren);
- Bezug-Nr. des Ersatzteils auf der Zeichnung (Pos.), Zeichnungsnummer (Tav.) und Kodenummer (codice)

N.B.: die Angaben rechts und links verstehen sich so, dass man hinter der Maschine steht.

When ordering spare parts specify:

- *machine type and serial number (found on the machine or on the purchasing documents);*
- *reference number of the part on the relative drawing (Pos.), number of the drawing (Tav.) and part number (codice)*

N.B.: *right-hand or left-hand indications are made by viewing the machine from the rear.*

TAV. 1.0
GRUPPO TELAIO
ENSEMBLE CHASSIS
SATZ FÜR RAHMEN
KIT FOR FRAME

TAV. 2.0
GRUPPO RACCOGLITORE IDRAULICO
ENSEMBLE RAMASSEUR HYDRAULIQUE
SATZ AUFNAHMEBEHAELTER
HYDRAULIC GRASS CATCHER

TAV. 3.0
GRUPPO TRASMISSIONE ROTORE
ENSEMBLE TRANSMISSION ROTOR
SATZ FÜR DEN ROTARONTRIEB
KIT FOR THE ROTOR TRANSMISSION

TAV.4.0
GRUPPO RULLO POSTERIORE
ENSEMBLE ROULEAU ARRIERE
SATZ HINTERE WALZE
KIT REAR ROLLER

TAV. 5.0
GRUPPO MOLTIPLICATORE
ENSEMBLE MULTIPLICATEUR
SATZ FÜR GETRIEBE
KIT FOR GEAR BOX

TAV. 6.0
RULLO ANTERIORE
ROULEAU AVANT
VIRDERE WALZE
FRONT ROLLER

TAV. 7.0
ALBERO CARDANICO COMPLETO - AB207SF
ARBRE A JOINTS DE CARDAN - AB207SF
KARDANWELLE - AB207SF
PTO SHAFT - AB207SF

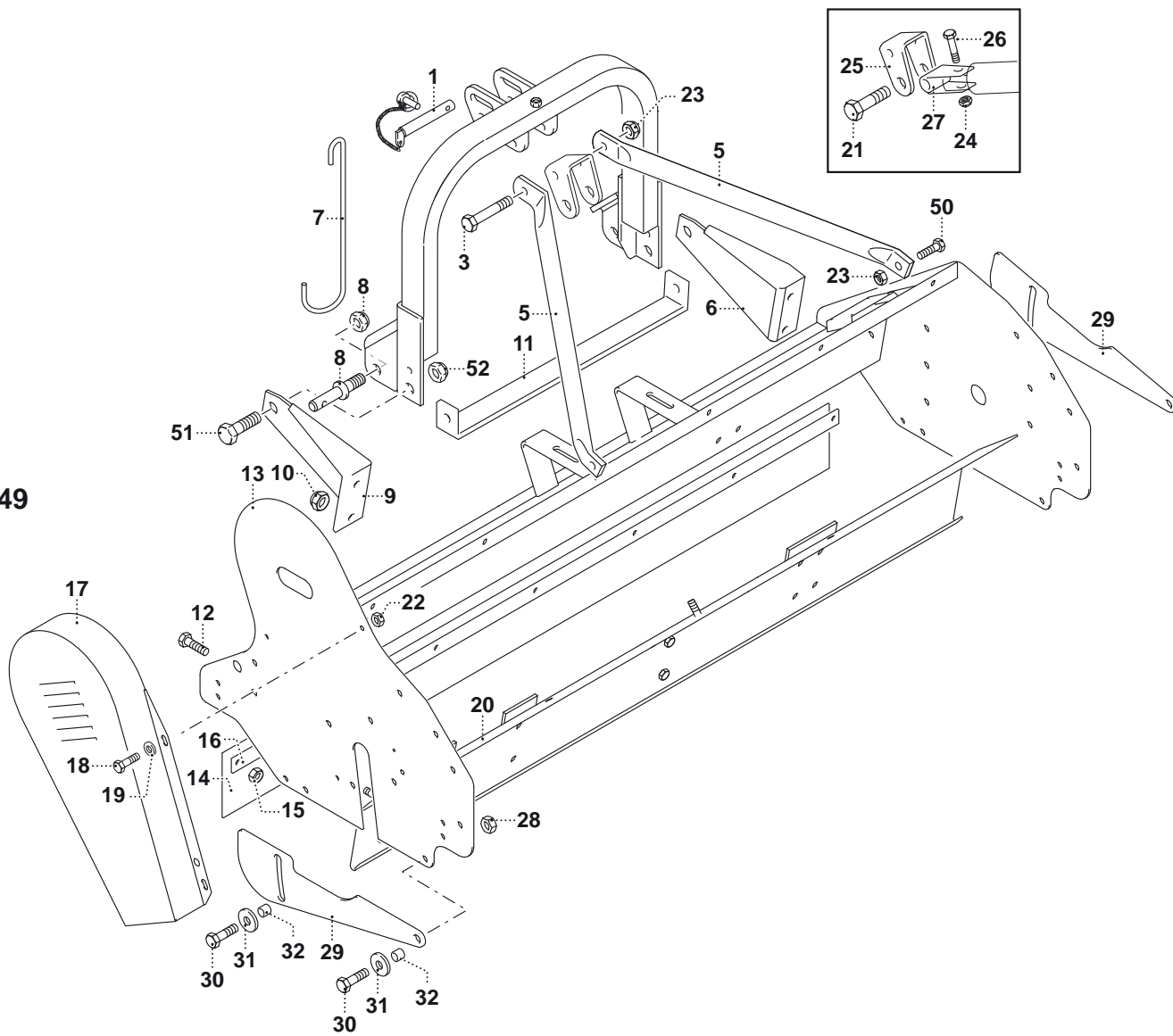
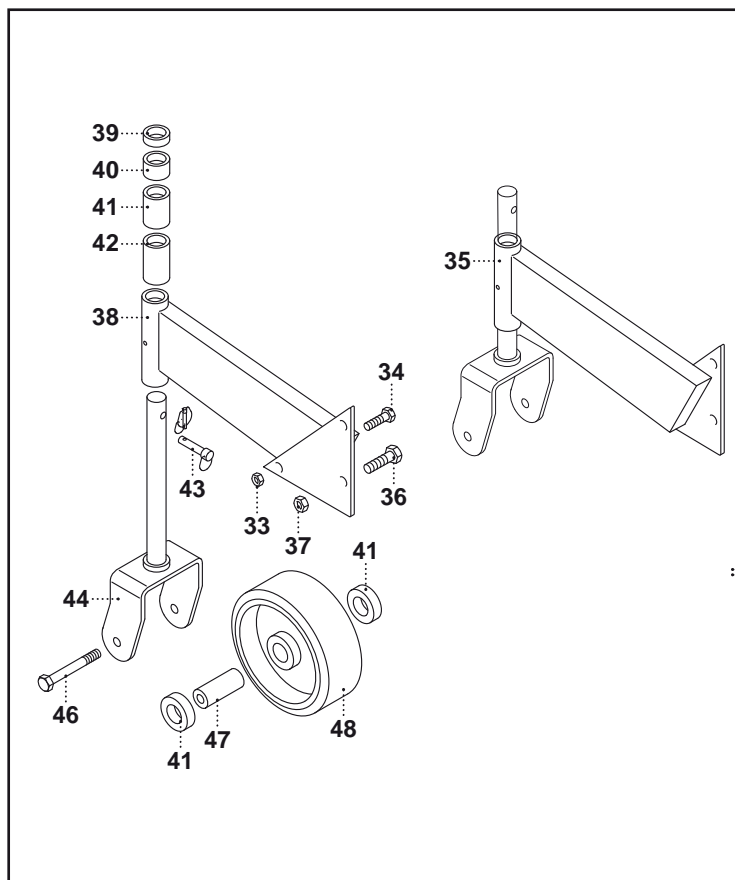

MURATORI MT 30 R

TAV. 1.0

POS.	N°	CODICE Q.	DESCRIZIONE	DESIGNATION	BENENNUNG	DESCRIPTION	DESIGNAZIONE	Da matr.	Fino matr.
								De nr. serie Vom Seriennr. From serial nr.	Jusqu'au nr. serie Bis Seriennr. Up to serial nr.
1	68062000	1	PERNO	PIVOT	BOLZEN	PIN			
2	40315700	1	ATTACCO	ATTACHE	ANSCHLUSS	ATTACHMENT			
3	60033000	1	VITE	VIS	SCHRAUBE	SCREW	TE 12 x 130 UNI 5737		
4	62010600	4	DADO	ECROU	MUTTER	NUT	M 12 x 1,75 AUTOBLOCC.		
5	32175200	2	TIRANTE	TIRANT	STANGE	TIEROD			
6	39169000	1	MENSOLA SX	CONSOLE (G)	KONSOLE (LINKS)	BRACKET (LH)			
7	38024500	1	GANCIO	CROCHET	HAKEN	HOOK			
8	68062500	2	PERNO	PIVOT	BOLZEN	PIN			
9	39168900	1	MENSOLA DX	CONSOLE (D)	KONSOLE (RECHTS)	BRACKET (RH)			
10	62010600	4	DADO	ECROU	MUTTER	NUT	M 12 x 1,75 AUTOBLOCC.		
11	30199700	1	TIRANTE	TIRANT	STANGE	TIEROD			
12	60022800		VITE	VIS	SCHRAUBE	SCREW	TE 8 x 20 UNI 5739		
13	41130100	1	TELAIO	CHASSIS	RAHMEN	FRAME	130		
13	41130200	1	TELAIO	CHASSIS	RAHMEN	FRAME	155		
14	68067900	1	BANDELLA	BANDE	BAND	STRAP	130		
14	68068000	1	BANDELLA	BANDE	BAND	STRAP	155		
15	62010200		DADO	ECROU	MUTTER	NUT	M 8 x 1,25 AUTOBLOCC.		
16	30125600	1	PIATTO	PLAQUE	PLATTE	PLATE	130		
16	30125700	1	PIATTO	PLAQUE	PLATTE	PLATE	155		
17	40227701	1	CARTER	CARTER	KETTENKASTEN	CASING			
18	60022800	4	VITE	VIS	SCHRAUBE	SCREW	TE 8 x 20 UNI 5739		
19	61006200	4	RONDELLA	RONDELLE	SCHEIBE	WASHER	PIANA Øi 9 Øe 24		
20	40283600	1	RINFORZO	RENFORT	VERSTÄRKUNG	REINFORCEMENT	130		
20	40283700	1	RINFORZO	RENFORT	VERSTÄRKUNG	REINFORCEMENT	155		
21	60031800		VITE	VIS	SCHRAUBE	SCREW	TE 22 x 90 UNI 5737		
22	62010200	4	DADO	ECROU	MUTTER	NUT	M 8 x 1,25 AUTOBLOCC.		

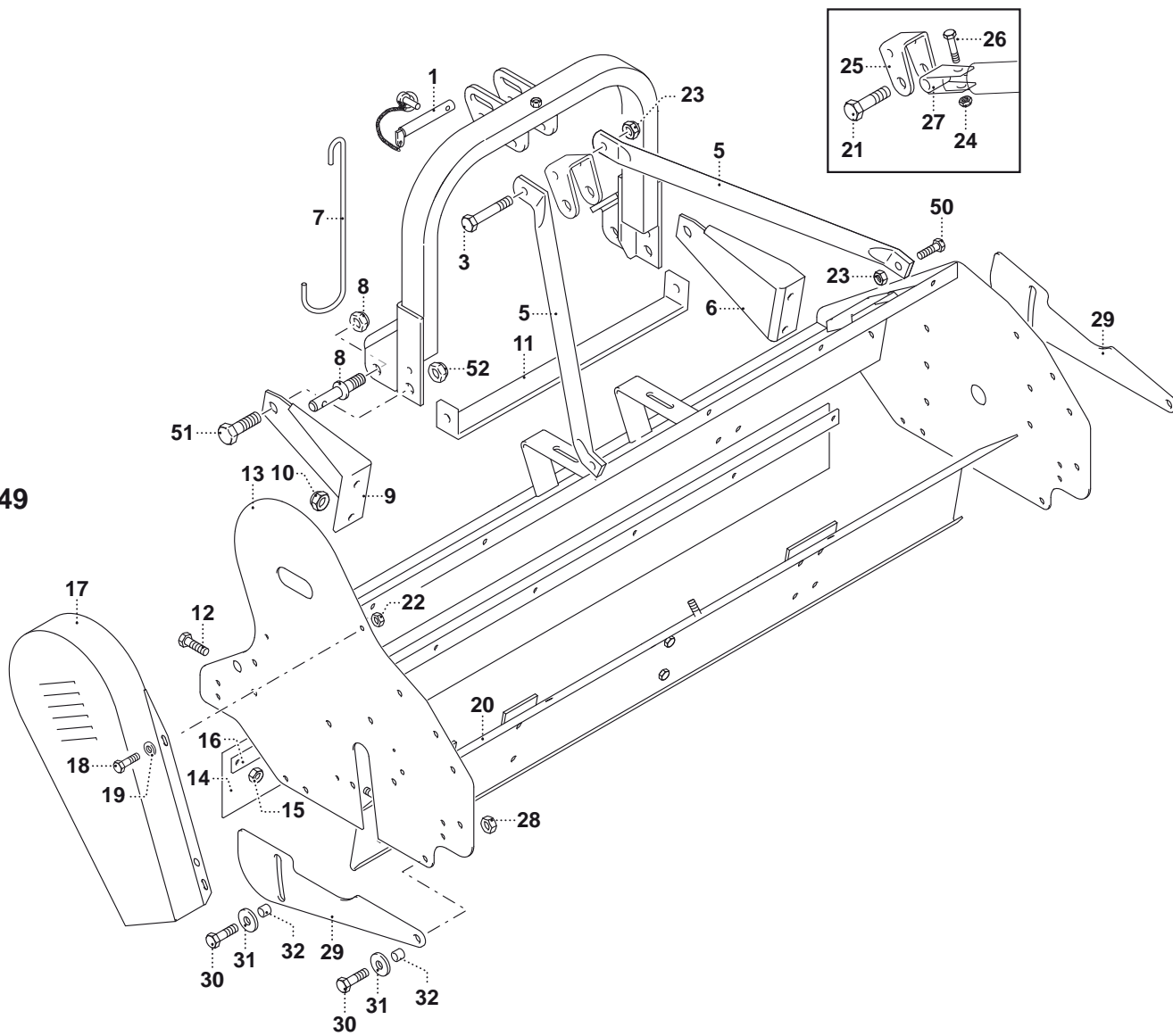
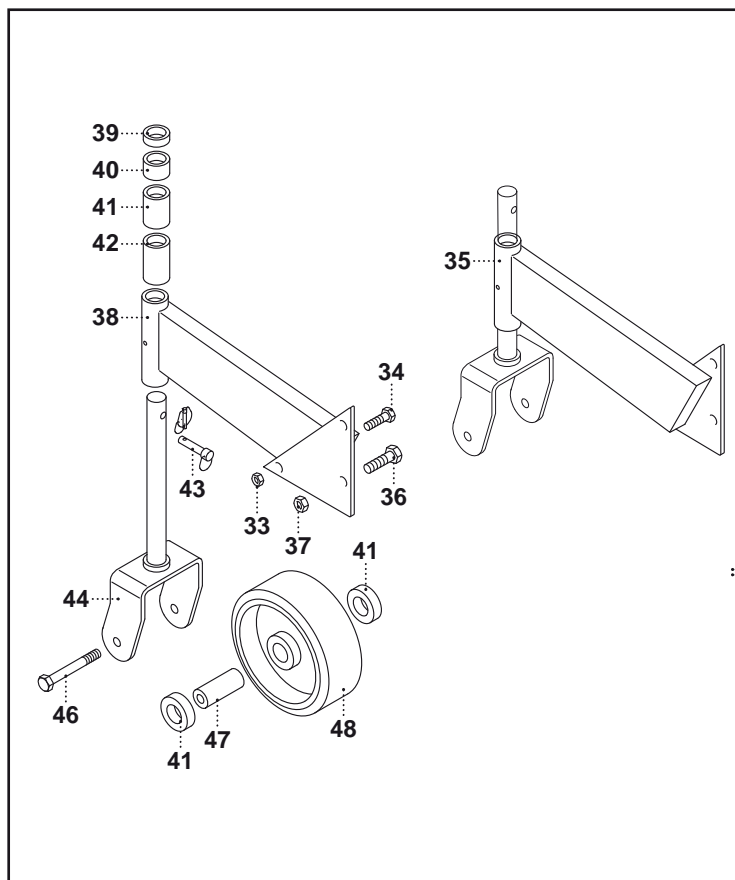

MURATORI MT 30 R

TAV. 1.0

POS.	N°	CODICE Q.	DESCRIZIONE	DESIGNATION	BENENNUNG	DESCRIPTION	DESIGNAZIONE	Da matr.	Fino matr.
								De nr. serie Vom Seriennr. From serial nr.	Jusqu'au nr. serie Bis Seriennr. Up to serial nr.
23	62010600	3	DADO	ECROU	MUTTER	NUT	M 12 AUTOBLOCC.		
24	62011600	1	DADO	ECROU	MUTTER	NUT	M 22 AUTOBLOCC.		
25	39337100	1	FORCELLA	FOURCHE	GABEL	YOKE			
26	60031400	1	VITE	VIS	SCHRAUBE	SCREW	TE 14 x 45 UNI 5739		
27	40268400	1	FORCELLA	FOURCHE	GABEL	YOKE			
28	62010400	4	DADO	ECROU	MUTTER	NUT	M 10 x 1,5 AUTOBLOCC.		
29	39295800	2	BANDELLA	BANDE	BAND	STRAP			
30	60021300	4	VITE	VIS	SCHRAUBE	SCREW	TE 10 x 30 UNI 5739		
31	61003500	2	RONDELLA	RONDELLE	SCHEIBE	WASHER	PIANA Øi 11 Øe 30		
32	31079300	4	BOCCOLA	DOUILLE	BUECHSE	BUSHING			
33	62010600	4	DADO	ECROU	MUTTER	NUT	M 12 x 1,75 AUTOBLOCC.		
34	60020400	4	VITE	VIS	SCHRAUBE	SCREW	TE 12 x 25 UNI 5739		
35	40268600	1	STAFFA DX	BRIDE (D)	BÜGEL (RECHTS)	BRACKET (RH)			
36	60017900	2	VITE	VIS	SCHRAUBE	SCREW	TE 10 x 25 UNI 5739		
37	62010400	2	DADO	ECROU	MUTTER	NUT	M 10 x 1,5 AUTOBLOCC.		
38	40268500	1	STAFFA SX	BRIDE (G)	BÜGEL (LINKS)	BRACKET (LH)			
39	32174600	4	SPESSORE	EPAISSEUR	DISTANZRING	SPACER	H=6		
40	32174700	4	SPESSORE	EPAISSEUR	DISTANZRING	SPACER	H=12		
41	32174900	8	SPESSORE	EPAISSEUR	DISTANZRING	SPACER	H=24		
42	32175000	2	SPESSORE	EPAISSEUR	DISTANZRING	SPACER	H=32		
43	64004800	2	SPINA	GOUPILLE	STIFT	PIN	Ø 8		
44	40234300	2	FORCELLA	FOURCHE	GABEL	YOKE			
45	62010600	2	DADO	ECROU	MUTTER	NUT	M 12 x 1,75 AUTOBLOCC.		
46	60033000	2	VITE	VIS	SCHRAUBE	SCREW	TE 12x 130 UNI 5737		
47	38023500	2	BOCCOLA	DOUILLE	BUECHSE	BUSHING			
48	68087600	2	RUOTA	ROUE	RAD	WHEEL			

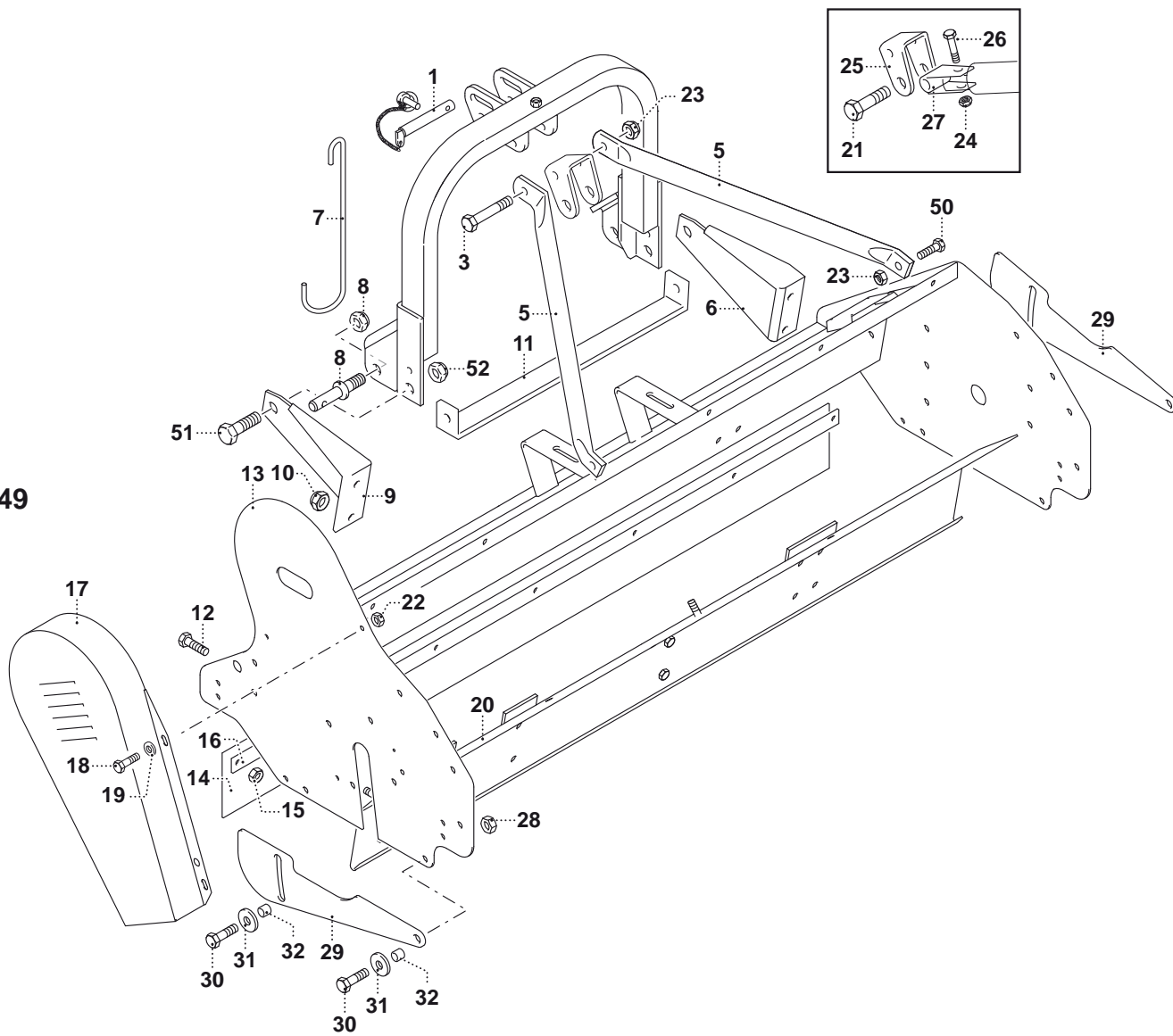
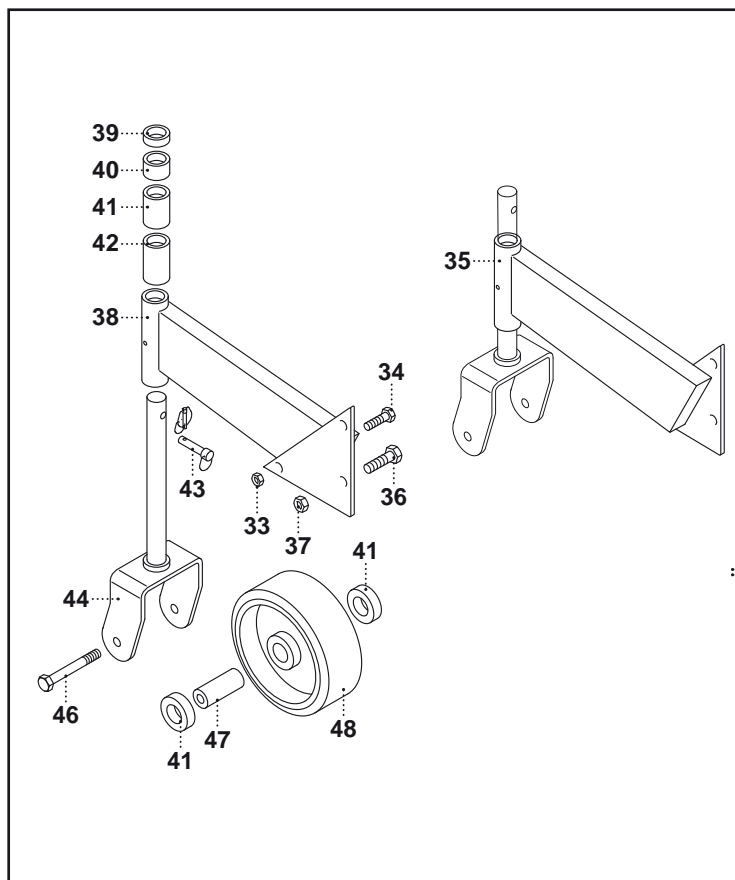

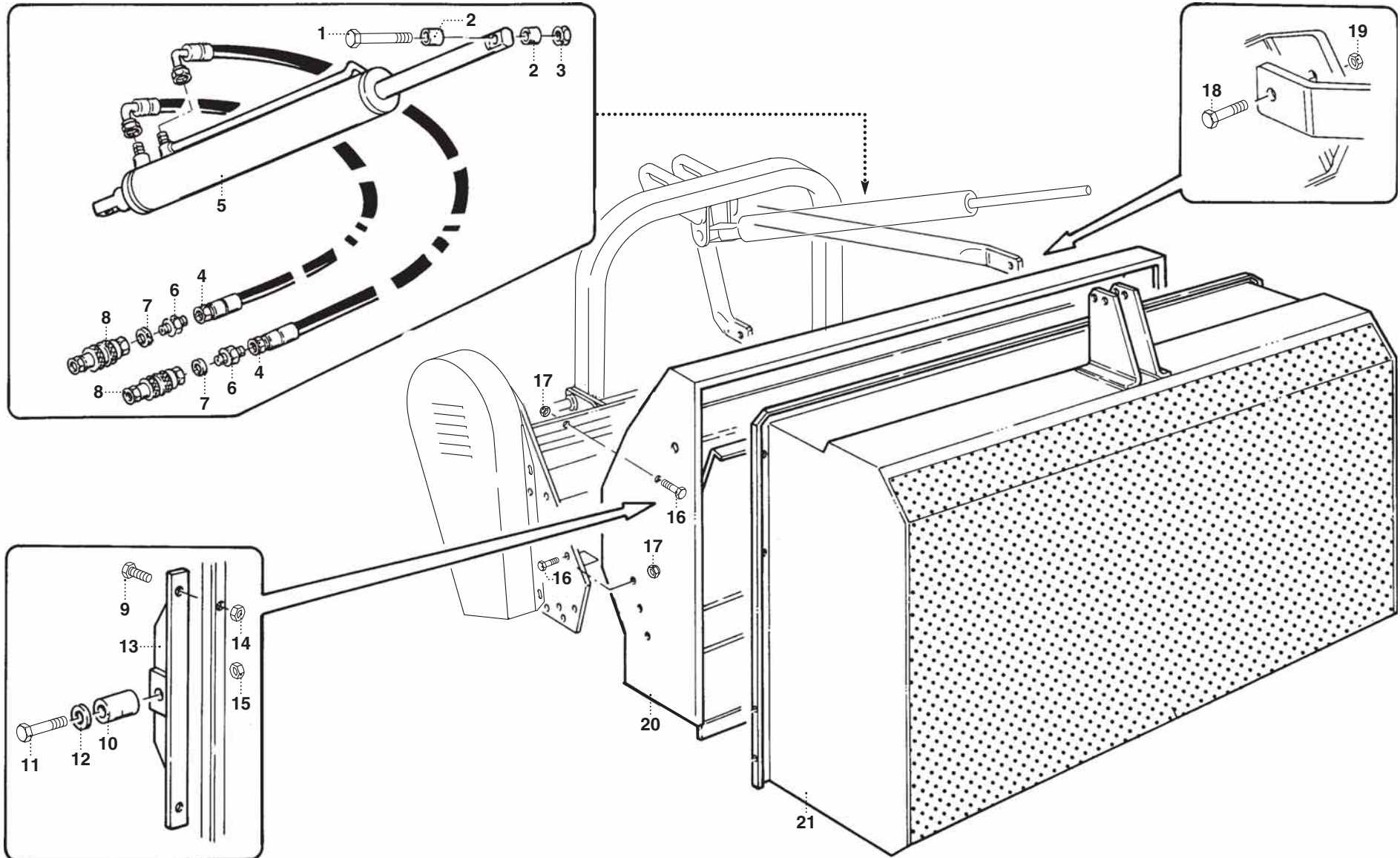

MURATORI MT 30 R

TAV. 3.0

POS.	N°	CODICE Q.	DESCRIZIONE	DESIGNATION	BENENNUNG	DESCRIPTION	DESIGNAZIONE	Da matr.	Fino matr.
								De nr. serie Vom Seriennr. From serial nr.	Jusqu'au nr. serie Bis Seriennr. Up to serial nr.
1	65001100	1	LINGUETTA	CLAVETTE	FEDER	KEY	8 x 7 x 30 UNI 6604		
2	60015100	2	VITE	VIS	SCHRAUBE	SCREW	TE 8 x 16 UNI 5739		
3	60021600	2	VITE	VIS	SCHRAUBE	SCREW	TE 10 x 130 UNI 5737		
4	61004900	2	RONDELLA	RONDELLE	SCHEIBE	WASHER	PIANA Ø 10 UNI 6592		
5	68074300	1	PROTEZIONE	PROTECTION	SCHUTZ	GUARD			
6	61004700	2	RONDELLA	RONDELLE	SCHEIBE	WASHER	PIANA Ø 8 UNI 6592		
7	40265901	1	PROTEZIONE	PROTECTION	SCHUTZ	GUARD	130		
7	40266001	1	PROTEZIONE	PROTECTION	SCHUTZ	GUARD	155		
8	40228601	1	PROLUNGA	RALLONGE	VERLÄNGERUNGSROHR	EXTENSION	130		
8	40228701	1	PROLUNGA	RALLONGE	VERLÄNGERUNGSROHR	EXTENSION	155		
9	61005000	3	RONDELLA	RONDELLE	SCHEIBE	WASHER	PIANA Ø 12 UNI 6592		
10	62010600	2	DADO	ECROU	MUTTER	NUT	M 12 x 1,75 AUTOBLOCC.		
11	67012600	1	SUPPORTO	SUPPORT	TRÄGER	SUPPORT	UCP 205		
12	60010100	2	VITE	VIS	SCHRAUBE	SCREW	TE 12 x 65 UNI 5737		
13	30212500	1	SPESSORE	EPAISSEUR	DISTANZRING	SPACER			
14	40161400	1	TIRANTE	TIRANT	STANGE	TIEROD			
15	62007000	2	DADO	ECROU	MUTTER	NUT	M 10 x 1,5 UNI 5588		
16	68121200	1	PULEGGIA	POULIE	RIEMENSCHLEIBE	PULLEY	Ø 170 3 SPA		
17	68058900	1	CALETTATORE	DISPOSITIF D'ASSEMBLAGE	SPANNSATZ	LOCKING DEVICE	Øi 25 Øe 55		
18	68059000	1	CALETTATORE	DISPOSITIF D'ASSEMBLAGE	SPANNSATZ	LOCKING DEVICE	Øi 35 Øe 55		
19	68059200	1	PULEGGIA	POULIE	RIEMENSCHLEIBE	PULLEY	Ø 100 3 SPA		
20	68121300	3	CINGHIA	COURROIE	KEILRIEMEN	BELT	A 41		
21	64000200	1	INGRASSATORE	GRAISSEUR	SCHMIERNIPPEL	GREASE FITTING	M 6 x 1		
22	60020400	4	VITE	VIS	SCHRAUBE	SCREW	TE 12 x 25 UNI 5735		
23	62010600	4	DADO	ECROU	MUTTER	NUT	M 12 x 1,75 AUTOBLOCC.		
24	40228000	1	SUPPORTO SX	SUPPORT (G)	TRÄGER (LINKS)	SUPPORT (LH)			

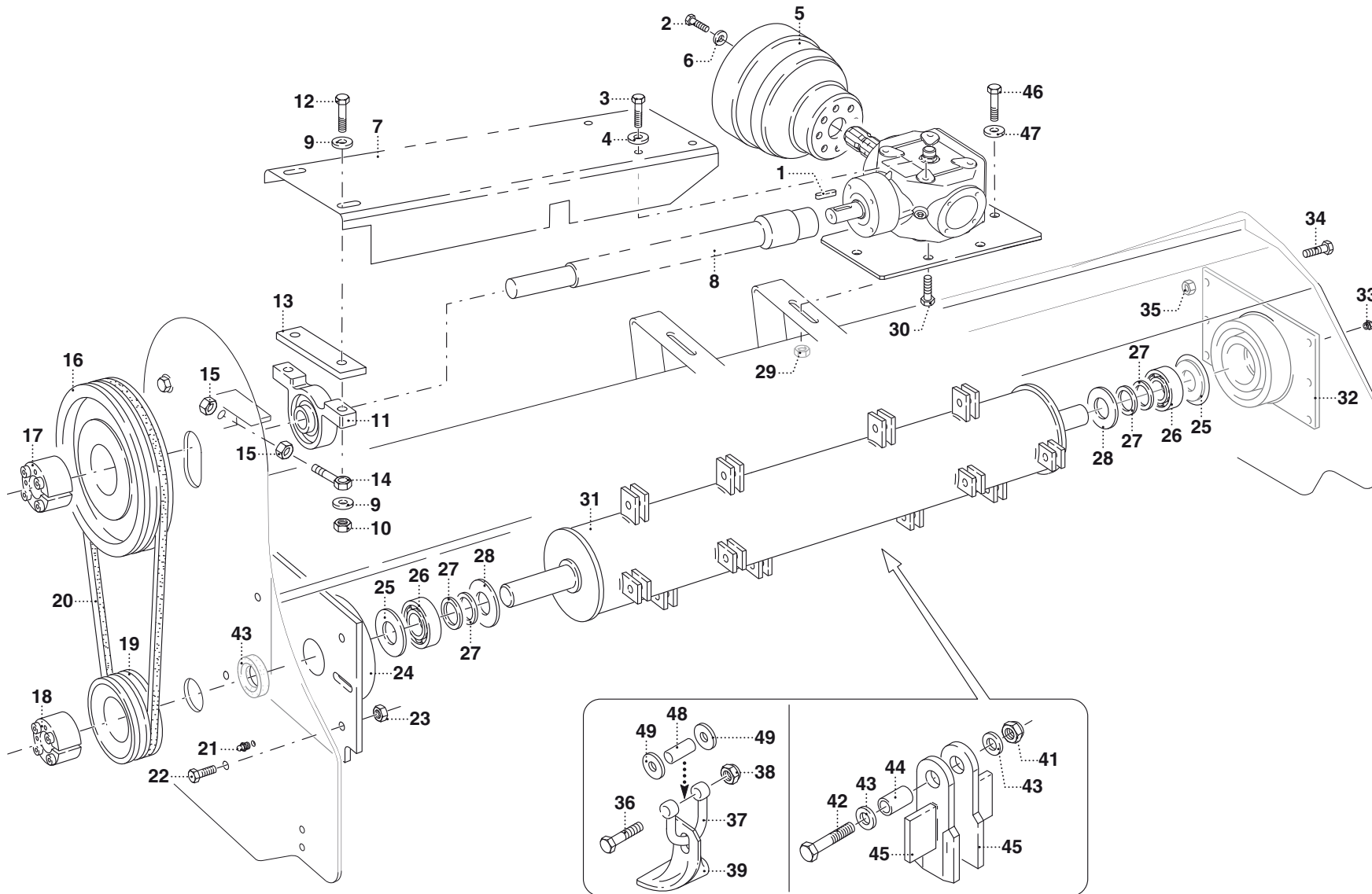

MURATORI MT 30 R

TAV. 3.0

POS.	N°	CODICE Q.	DESCRIZIONE	DESIGNATION	BENENNUNG	DESCRIPTION	DESIGNAZIONE	Da matr.	Fino matr.
								De nr. serie Vom Seriennr. From serial nr.	Jusqu'au nr. serie Bis Seriennr. Up to serial nr.
25		32068000 2	SPESSORE	EPAISSEUR	DISTANZRING	SPACER			
26		67012900 2	CUSCINETTO	ROULEMENT	LAGER	BEARING	1306		
27		68068800	SPESSORE	EPAISSEUR	DISTANZRING	SPACER	42 x 30 x 1		
28		39091100 2	DISCO	DISQUE	SCHEIBE	DISC	Øe 70 Øi 30 sp. 1,5		
29		62010600 2	DADO	ECROU	MUTTER	NUT	M 12 x 1,75 AUTOBLOCC.		
30		60021600 4	VITE	VIS	SCHRAUBE	SCREW	TE 10 x 20 UNI 5739		
31		42045500 1	ROTORE	ROTOR	ROTOR	ROTOR	130		
31		42045600 1	ROTORE	ROTOR	ROTOR	ROTOR	155		
32		40084600 1	SUPPORTO DX	SUPPORT (D)	TRÄGER (RECHTS)	SUPPORT (RH)			
33		64001800 1	INGRASSATORE	GRAISSEUR	SCHMIERNIPPEL	GREASE FITTING	M 10 x 1 DIRITTO		
34		60020400 6	VITE	VIS	SCHRAUBE	SCREW	TE 12 x 25 UNI 5739		
35		62010600 6	DADO	ECROU	MUTTER	NUT	M 12 x 1,75 AUTOBLOCC.		
36		60007700	VITE	VIS	SCHRAUBE	SCREW	TE 14 x 70 UNI 5737		
36		60023300 2	VITE	VIS	SCHRAUBE	SCREW	TE 14 x 60 UNI 5737	136429	
36		60030200	VITE	VIS	SCHRAUBE	SCREW	TE 10 x 80 UNI 5739 8.8 ZNT	136430	
37		68074000	CAVALLOTTO	ARRETOIR	KLEMMSTÜCK	UBOLT		136429	
37		68129200	CAVALLOTTO	ARRETOIR	KLEMMSTÜCK	UBOLT	136430		
38		62010800	DADO	ECROU	MUTTER	NUT	M 14 x 2 AUTOBLOCC.	136429	
38		62010400	DADO	ECROU	MUTTER	NUT	M 10 x 1,5 AUTOBLOCC.	136430	
39		12015100	COLTELLO A SPATOLE	COUTEAU	MESSER	KNIFE			
40		66014000	ANELLO TENUTA	JOINT D'ETANCHEITE	DICHTUNGSRING	JUNT RING	30 x 40 x 4		
41		62010200	DADO	ECROU	MUTTER	NUT	M 8 AUTOBLOCC.		
42		60034400	VITE	VIS	SCHRAUBE	SCREW	TE 8 x 55 UNI 5737		
43		61006200	RONDELLA	RONDELLE	SCHEIBE	WASHER	PIANA Øe 24 Øi 9		
44		31067500	BOCCOLA	DOUILLE	BÜCHSE	BUSHING			
45		12016600	COLTELLO VERTICUT	COUTEAU VERTICUT	VERTICUT MESSER	VERTICUT KNIFE			

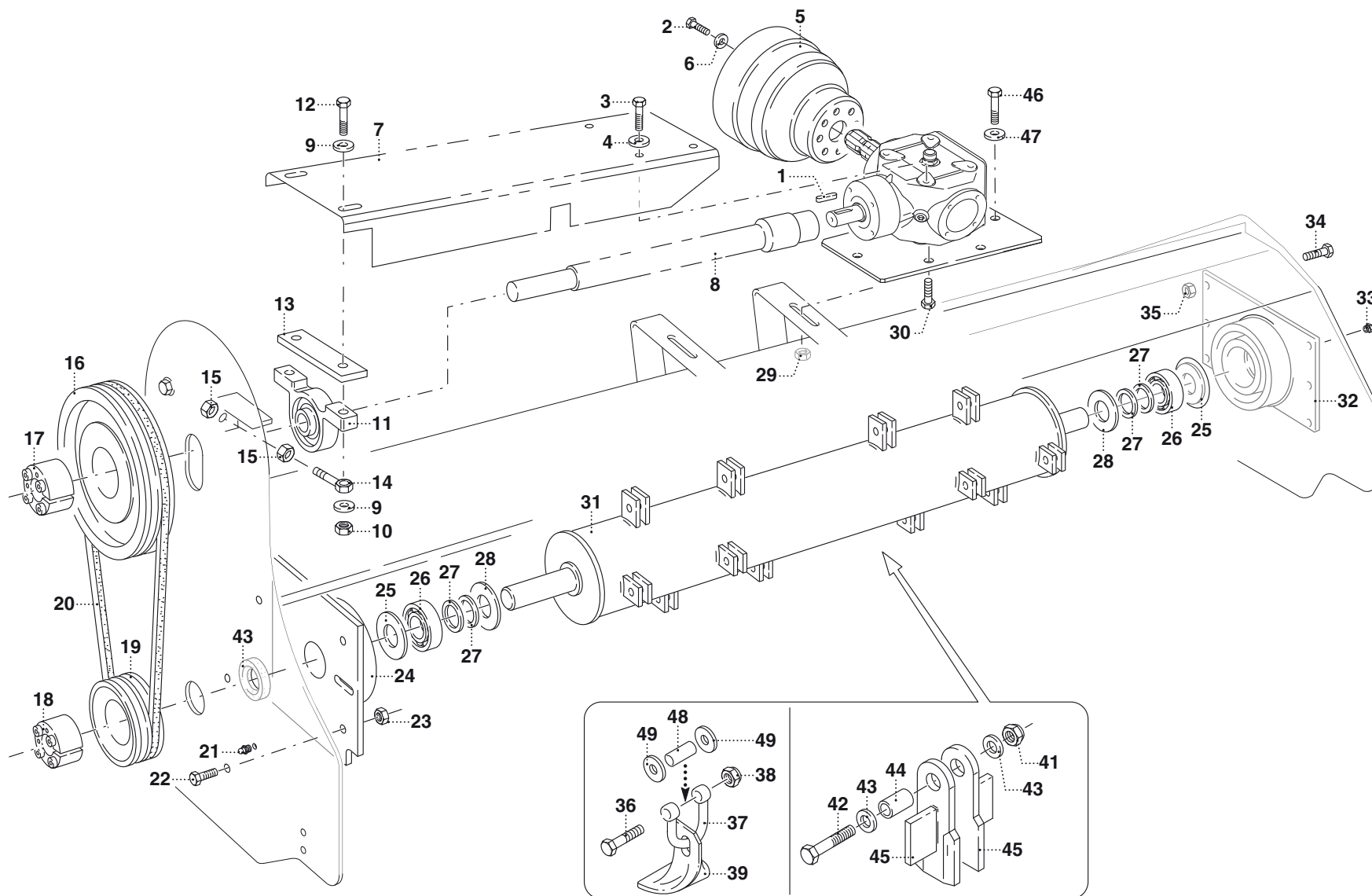

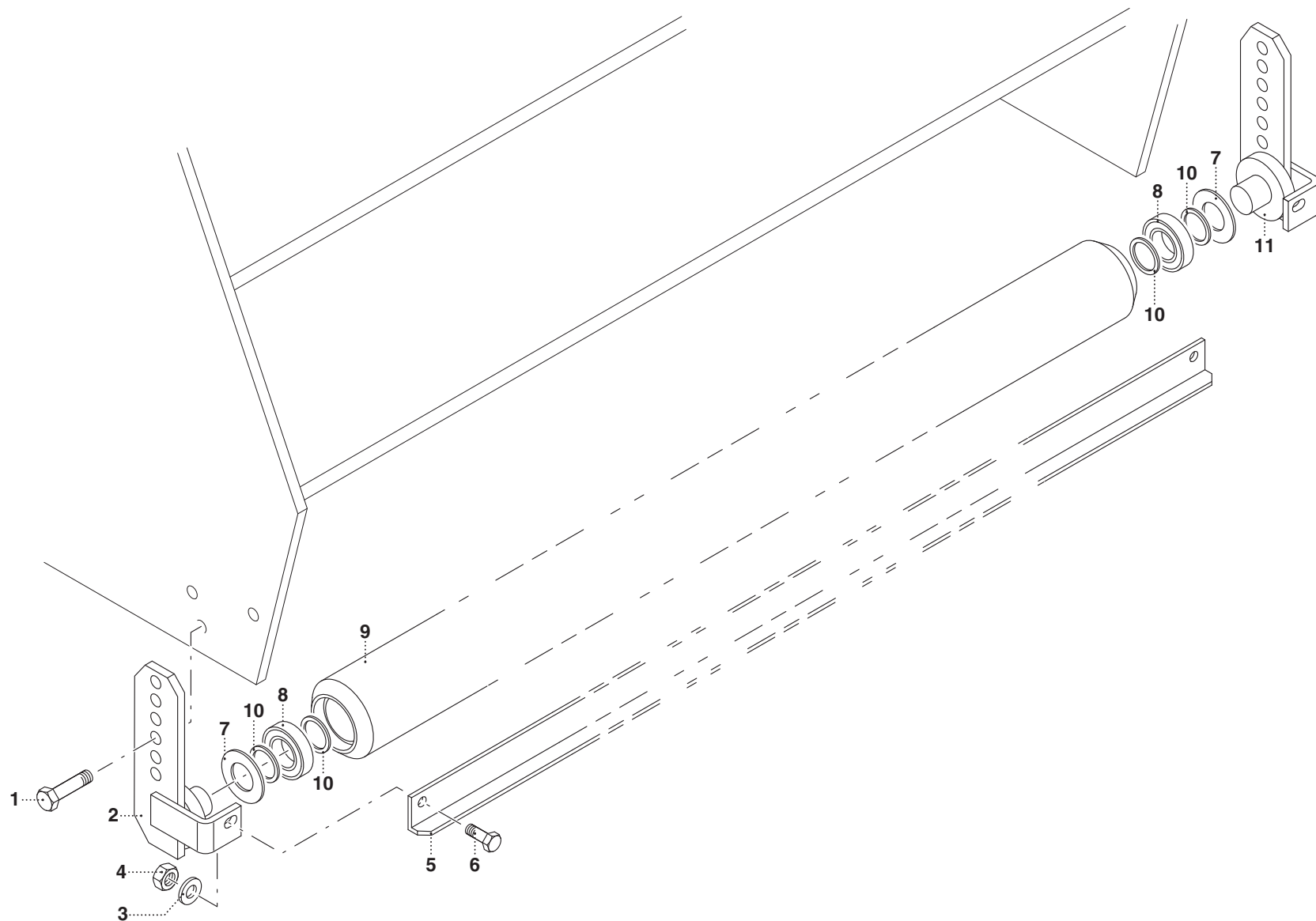

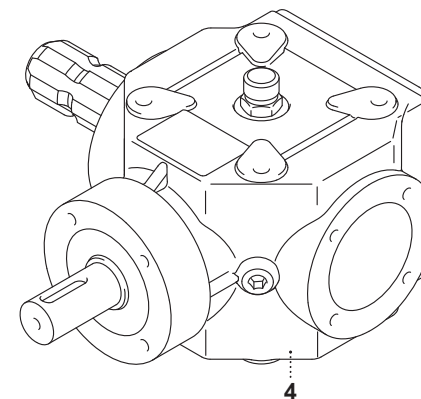
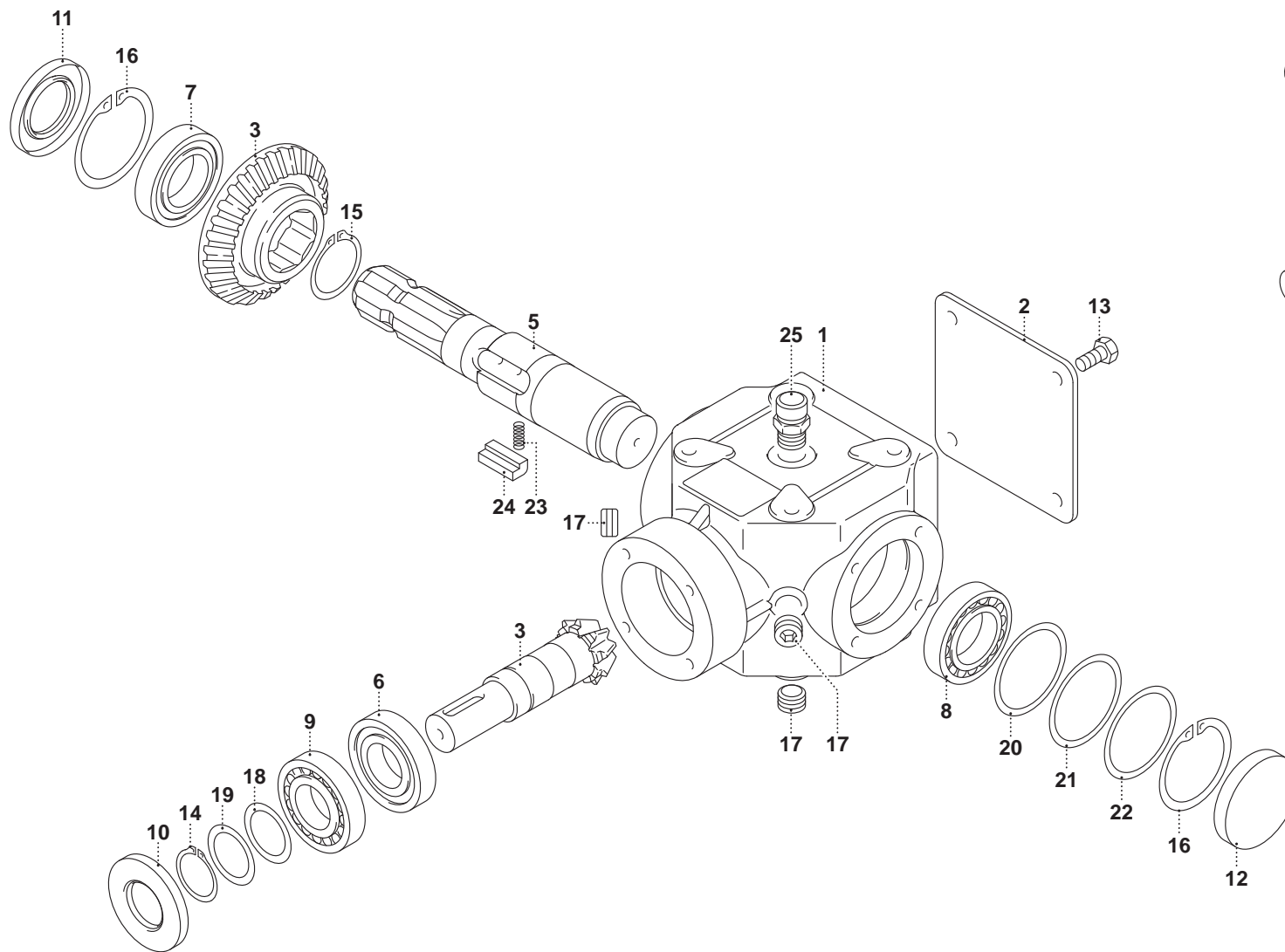

MURATORI MT 30 R

TAV. 5.0

POS.	N°	CODICE Q.	DESCRIZIONE	DESIGNATION	BENENNUNG	DESCRIPTION	DESIGNAZIONE	Da matr.	Fino matr.
								De nr. serie Vom Seriennr. From serial nr.	Jusqu'au nr. serie Bis Seriennr. Up to serial nr.
1	01020400	1	SCATOLA	CARTER	GEHÄUSE	GEARBOX			
2	39340600	1	COPERCHIO	COUVERCLE	DECKEL	COVER			
3	10050900	1	COPPIA CONICA	COUPLE CONIQUE	KEGELRADTRIEB.	BEVEL GEAR PAIR			
4	46042000	1	MOLTIPLICATORE ORARIO	BOITIER (ROT. STANDARD)	RECHTSDR. GETRIEBE	CLOCKWISE GEAR BOX			
4	46042200	1	MOLTIPLIC. ANTIORARIO	BOITIER (ROT. INVERSE)	LINKSDR. GETRIEBE	COUNTERCL. GEAR BOX			
5	31099200	1	ALBERO	ARBRE	WELLE	SHAFT			
6	67015700	1	CUSCINETTO	ROULEMENT	LAGER	BEARING	30206		
7	67017200	1	CUSCINETTO	ROULEMENT	LAGER	BEARING	30207		
8	67018500	1	CUSCINETTO	ROULEMENT	LAGER	BEARING	6007		
9	67018600	1	CUSCINETTO	ROULEMENT	LAGER	BEARING	6206		
10	66019700	1	ANELLO TENUTA	JOINT D'ETANCHEITE	DICHTUNGSRING	JUNT RING	30 x 62 x 8		
11	66011600	1	ANELLO TENUTA	JOINT D'ETANCHEITE	DICHTUNGSRING	JUNT RING	35 x 62 x 7		
12	68123900	1	CAPPELOTTO	BOUCHON	ABSCHLUSSKAPPE	CAP NUT	62 x 9,5		
13	60015100	4	VITE	VIS	SCHRAUBE	SCREW	TE 8 x 16 UNI 5739		
14	63005700	1	ANELLO ELASTICO	ARRETOIR	SPANNRING	SNAP-RING	Ø30 E UNI 7436		
15	63005000	1	ANELLO ELASTICO	ARRETOIR	SPANNRING	SNAP-RING	Ø42 E UNI 7435		
16	63005200	1	ANELLO ELASTICO	ARRETOIR	SPANNRING	SNAP-RING	Ø62 I UNI 7437		
17	68124500	3	TAPPO	BOUCHON	STOPFEN	PLUG			
18	68124100	1	SPESSORE	EPAISSEUR	DISTANZRING	SPACER	30 x 40 x 0,5		
19	68124200	1	SPESSORE	EPAISSEUR	DISTANZRING	SPACER	30 x 40 x 1		
20	68039000	1	SPESSORE	EPAISSEUR	DISTANZRING	SPACER	62 x 50 x 0,3		
21	68124300	1	SPESSORE	EPAISSEUR	DISTANZRING	SPACER	62 x 50 x 0,5		
22	68011500	2	SPESSORE	EPAISSEUR	DISTANZRING	SPACER	62 x 50 x 1		
23	68124400	6	MOLLA	RESSORT	FEDER	SPRING			
24	65003500	3	CHIAVETTA	CLAVETTE	KEIL	SPLINE			
25	68085600	1	TAPPO	BOUCHON	STOPFEN	PLUG			

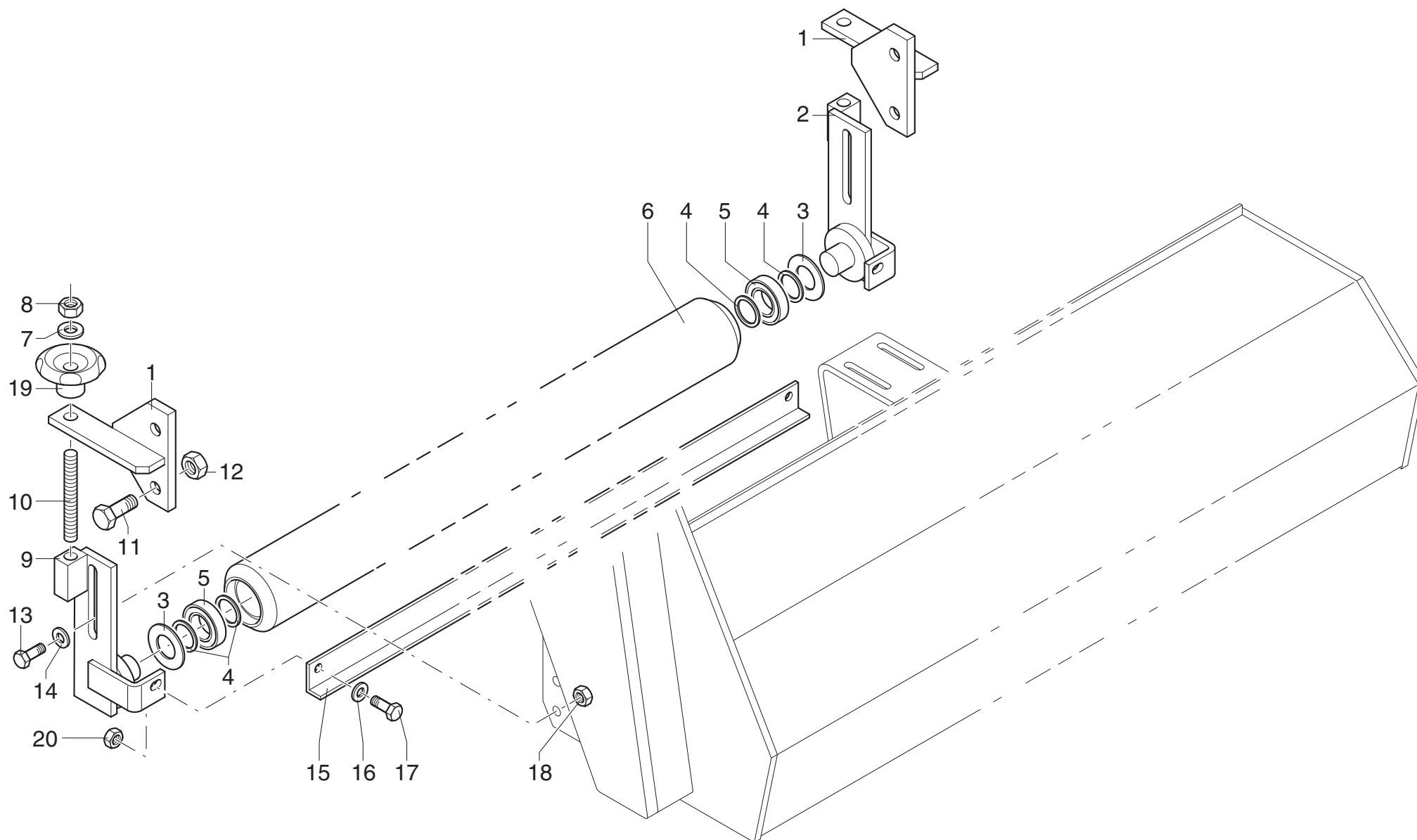

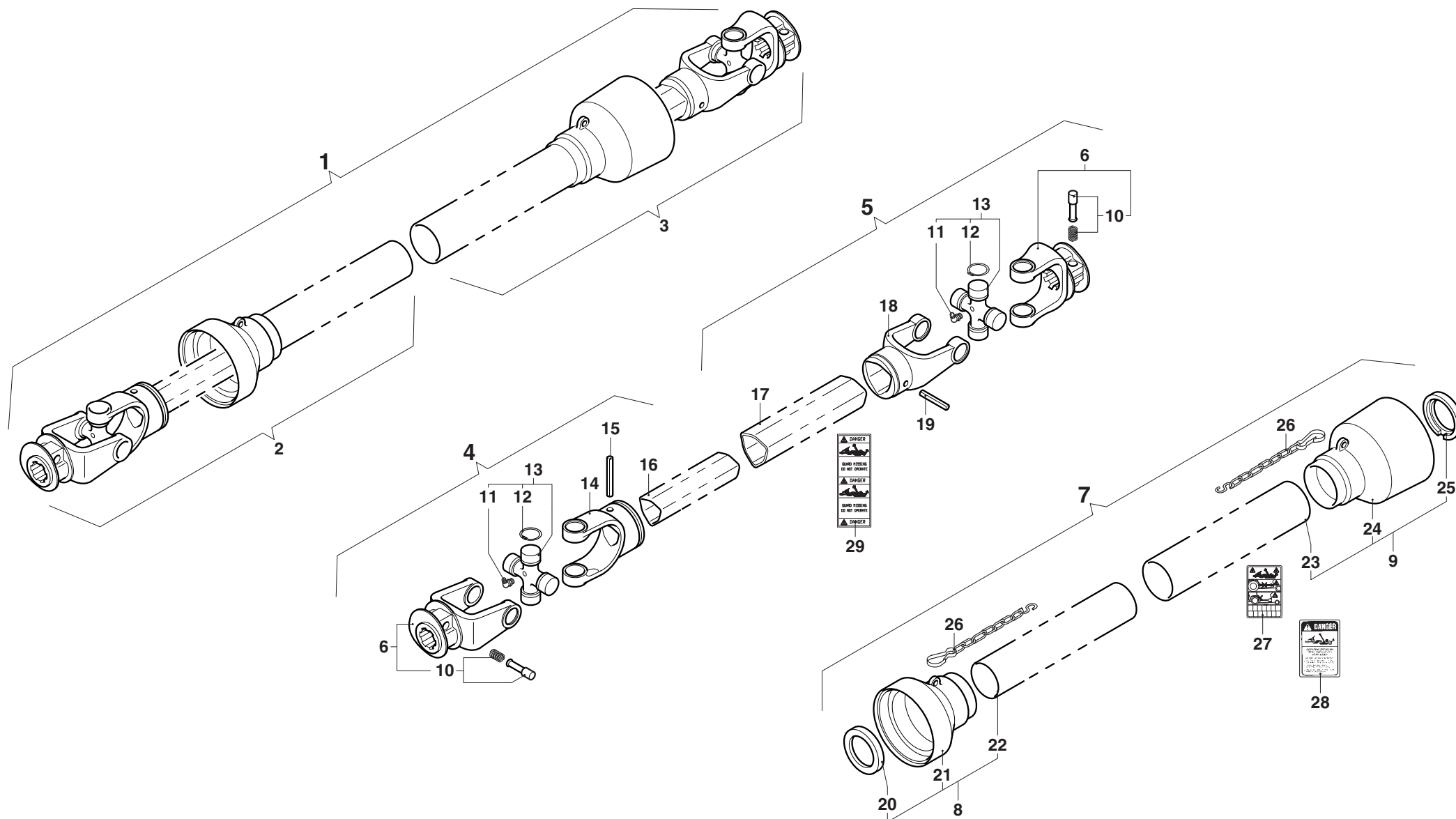

MURATORI MT 30 R

TAV. 7.0

POS.	N°	CODICE Q.	DESCRIZIONE	DESIGNATION	BENENNUNG	DESCRIPTION	DESIGNAZIONE	Da matr.	Fino matr.
								De nr. serie Vom Seriennr. From serial nr.	Jusqu'au nr. serie Bis Seriennr. Up to serial nr.
1	AB207SF	1	ALBERO CARDANICO COMPLETO	ARBRE A JOINTS DE CARDAN	KARDANWELLE	PTO SHAFT			
2	B2070B1	1	SEMIALBERO INTERNO	DEMI-ARBRE INTERIEUR	INNENHALBWELLE	INTERNAL HALF SHAFT			
3	B2070B2	1	SEMIALBERO ESTERNO	DEMI-ARBRE EXTERIEUR	AUSSENHALBWELLE	EXTERNAL HALF SHAFT			
4	B207001	1	SEMIALBERO INTERNO	DEMI-ARBRE INTERIEUR	INNENHALBWELLE	INTERNAL HALF SHAFT			
5	B2070002	1	SEMIALBERO ESTERNO	DEMI-ARBRE EXTERIEUR	AUSSENHALBWELLE	EXTERNAL HALF SHAFT			
6	0800203	2	FORCELLA	FOURCHE	GABEL	YOKE			
7	083B02070	1	PROTEZIONE	PROTECTION	SCHUTZ	GUARD			
8	083B020701	1	PROTEZIONE INTERNA	PROTECTION INTERIEURE	INNENSCHUTZ	INTERNAL GUARD			
9	083B020702	1	PROTEZIONE ESTERNA	PROTECTION EXTERIEURE	AUSSENSCHUTZ	EXTERNAL GUARD			
10	0986014047	2	PULSANTE	BOUTON	DRUCKKNOPF	PUSH BOTTON			
11	09840081002	2	INGRASSATORE	GRAISSEUR	SCHMIERNIPPEL	GREASE FITTING			
12	098020224	8	ANELLO ELASTICO	ARRETOIR	SPANNRING	SNAP-RING			
13	08202	2	CROCIERA	CROISILLON	KREUZSTÜCK	SPIDER			
14	08002011	1	FORCELLA	FOURCHE	GABEL	YOKE			
15	098700850	1	SPINA ELASTICA	GOUPILLE ELASTIQUE	SPANNSTIFT	ELASTIC PIN			
16	09881294100	1	TUBO INTERNO	TUBE INTERIEUR	INNENROHR	INTERNAL TUBE			
17	09881363100	1	TUBO ESTERNO	TUBE EXTERIEUR	AUSSENROHR	EXTERNAL TUBE			
18	08002021	1	FORCELLA	FOURCHE	GABEL	YOKE			
19	098700855	1	SPINA ELASTICA	GOUPILLE ELASTIQUE	SPANNSTIFT	ELASTIC PIN			
20	0265220008	1	GHIERA	FRETTE	NUTMUTTER	RING NUT			
21	0256010425	1	CUFFIA	CAPOUCHON	HAUBE	GUARD			
22	0988955B2070	1	TUBO INTERNO	TUBE INTERIEUR	INNENROHR	INTERNAL TUBE			
23	0988961B2070	1	TUBO ESTERNO	TUBE EXTERIEUR	AUSSENROHR	EXTERNAL TUBE			
24	0256010424	1	CUFFIA	CAPOUCHON	HAUBE	GUARD			
25	0265220007	1	GHIERA	FRETTE	NUTMUTTER	RING NUT			

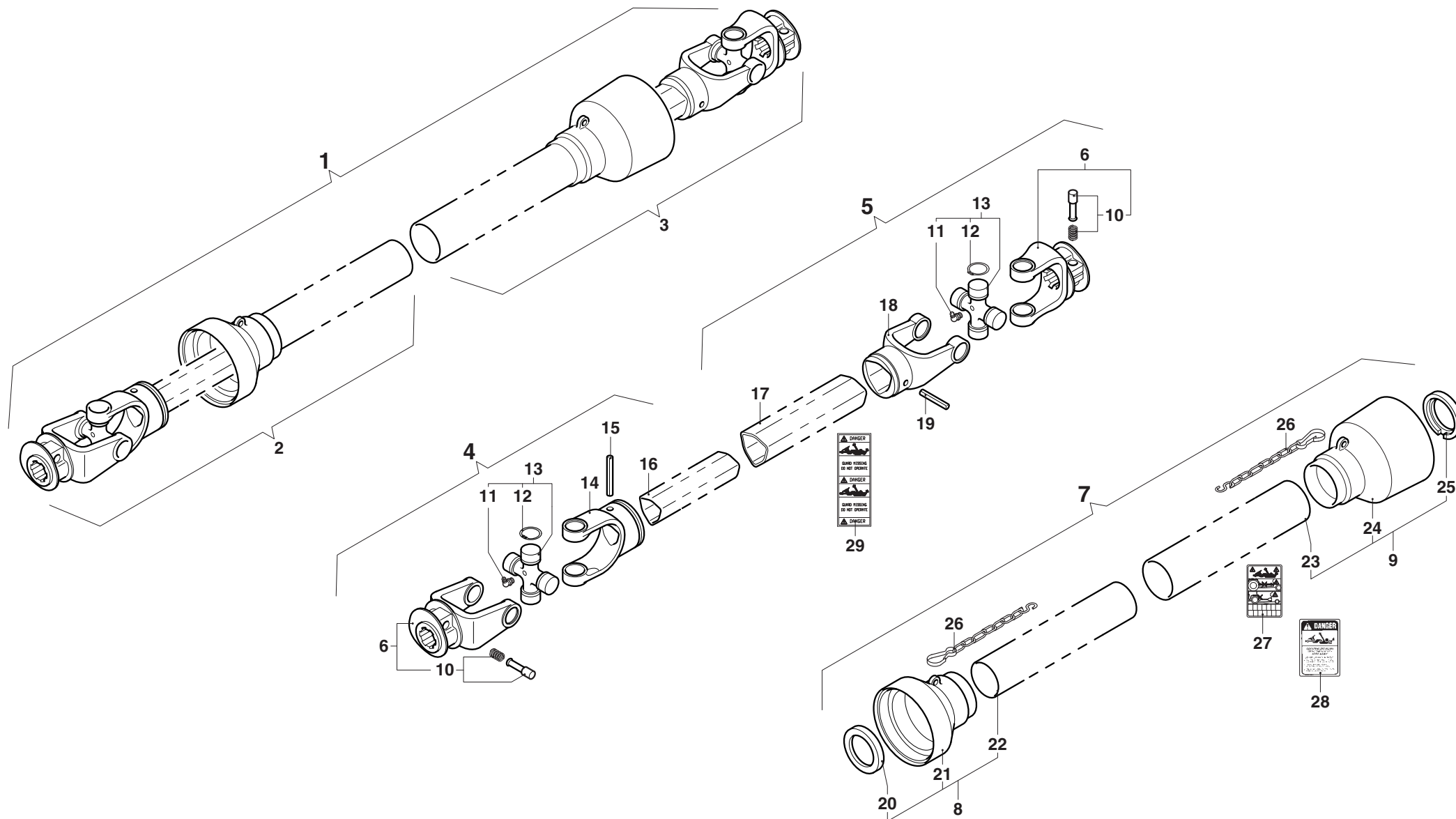



MURATORI S.p.A.

Via Pavarello, 21 - 41051 Castelnuovo Rangone (MO) Italy - Tel. 059.5330611 Fax 059.537259

www.muratoriequip.it *info@muratoriequip.it*

Capitale sociale Euro 480.000 interamente versato

Registro Imprese di Modena

Codice fiscale e numero d'iscrizione: 00708860366