



MURATORI

**TIPO-TYPE-TYP
MT 40**

**CATALOGO RICAMBI
Catalogue Pièces Detachées
Ersatzteilkatalog
Spare Parts Catalogue
Catálogo Recambios**

EDIZIONE 11/2016

Per ordinare parti di ricambio specificare:

- tipo e matricola della macchina (apposti sulla macchina o sui documenti di acquisto);
- numero del riferimento del pezzo nel disegno (Pos.), numero della tavola (Tav.) e numero di codice

N.B.: le indicazioni destro o sinistro vengono date guardando la macchina da dietro.

Pour les commandes de pièces de rechange veuillez spécifier:

- *type et numéro de série de la machine (indiqués sur la machine et sur le bon d'achat);*
- *numéro de référence du pièce sur le plan (Pos.), numéro du plan (Tav.) et numéro de code (codice)*

N.B.: *les indications droite ou gauche sont données en regardant la machine par derrière.*

Zum Bestellen von Ersatzteilen folgendes angeben:

- Typ und Serien-Nr. der Maschine (zu finden auf der Maschine oder der Einkaufspapieren);
- Bezug-Nr. des Ersatzteils auf der Zeichnung (Pos.), Zeichnungsnummer (Tav.) und Kodenummer (codice)

N.B.: die Angaben rechts und links verstehen sich so, dass man hinter der Maschine steht.

When ordering spare parts specify:

- *machine type and serial number (found on the machine or on the purchasing documents);*
- *reference number of the part on the relative drawing (Pos.) number of the drawing (Tav.) and part number (codice)*

N.B.: *right-hand or left-hand indications are made by viewing the machine from the rear.*

TAV. 1.0

GRUPPO TELAIO
ENSEMBLE CHASSIS
SATZ FÜR RAHMEN
KIT FOR FRAME

TAV. 2.0

GRUPPO RULLO ROTORE
ENSEMBLE ROTOR
SATZ FÜR ROTOR
KIT FOR ROTOR

TAV. 3.0

GRUPPO MOLTIPLICATORE
ENSEMBLE MULTIPLICATEUR
SATZ FÜR GETRIEBE
KIT FOR GEAR BOX

TAV. 4.0

GRUPPO RULLO POSTERIORE
ENSEMBLE ROULEAU ARRIERE
SATZ HINTERE WALZE
KIT REAR ROLLER

TAV. 5.0

ACCESSORI A COMPLETAMENTO
OPTIONS D'ACHEVEMENT
ZUBEHÖRE ZUR ERGANZUNG DER MASCHINE
CHOICE OF EQUIPMENT COMPLETING MACHINE

TAV. 6.0

ALBERO CARDANICO COMPLETO - AB409SF
ARBRE A JOINTS DE CARDAN - AB409SF
KARDANWELLE - AB409SF
PTO SHAFT - AB409SF

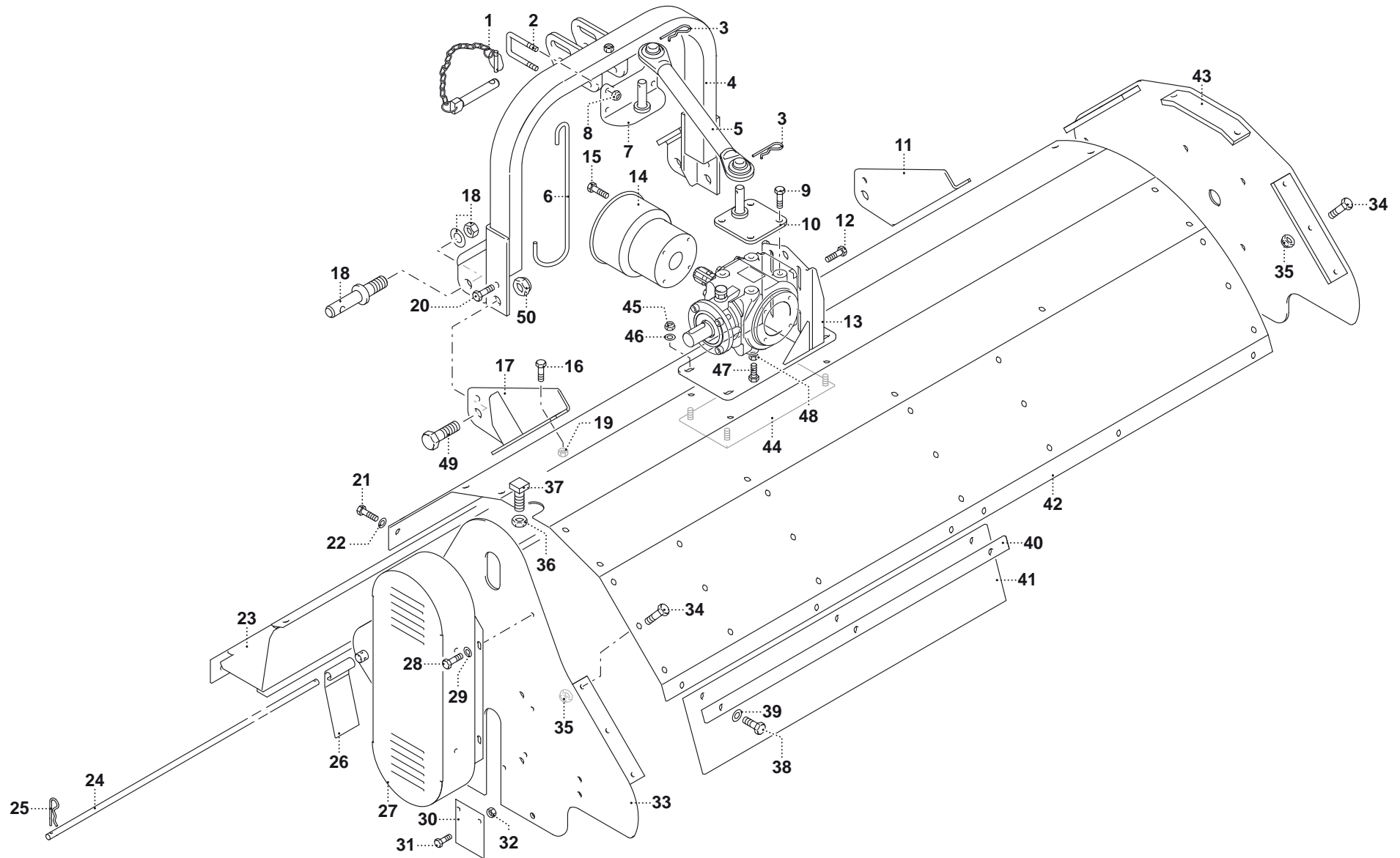

MURATORI MT 40

TAV. 1.0

POS.	N° CODICE	Q.	DESCRIZIONE	DESIGNATION	BENENNUNG	DESCRIPTION	DESIGNAZIONE	Da matr. De nr. serie Vom Seriennr. From serial nr.	Fino matr. Jusqu'au nr. serie Bis Seriennr. Up to serial nr.
1	68062000	1	PERNO	PIVOT	BOLZEN	PIN			
2	38028700	2	CAVALLOTTO	ARRETOIR	KLEMMSTÜCK	UBOLT			
3	64000300	2	COPIGLIA	COUPILLE	SPLINT	COTTER PIN	AR Ø 4		
4	40315700	1	ATTACCO	ATTACHE	ANSCHLUSS	ATTACHMENT			
5	40320000	1	TIRANTE	TIRANT	STANGE	TIEROD			
6	38024500	1	GANCIO	CROCHET	HAKEN	HOOK			
7	40319800	1	MENSOLA	CONSOLE	KONSOLE	BRACKET			
8	62010400	4	DADO	ECROU	MUTTER	NUT	M 10 x 1,5 AUTOBLOCC.		
9	60023000	4	VITE	VIS	SCHRAUBE	SCREW	TE 12 x 30 UNI 5739		
10	40319900	1	MENSOLA	CONSOLE	KONSOLE	BRACKET			
11	40320500	1	MENSOLA DX	CONSOLE (D)	KONSOLE (RECHTS)	BRACKET (RH)			
12	60023000	4	VITE	VIS	SCHRAUBE	SCREW	TE 12 x 30 UNI 5739		
13	40319600	1	SUPPORTO	SUPPORT	HALTERUNG	SUPPORT			
14	68061501	1	PROTEZIONE	PROTECTION	SCHUTZ	GUARD			
15	60015100	4	VITE	VIS	SCHRAUBE	SCREW	TE 8 x 16 UNI 5739		
16	60023000	6	VITE	VIS	SCHRAUBE	SCREW	TE 12 x 30 UNI 5739		
17	40320400	1	MENSOLA SX	CONSOLE (G)	KONSOLE (LINKS)	BRACKET (LH)			
18	68062000	2	PERNO COMPLETO	PIVOT COMPLET	KOMPL. BOLZEN	COMPLETE PIN			
19	62010600	8	DADO	ECROU	MUTTER	NUT	M 12 x 1,75 AUTOBLOCC.		
20	60021200	2	VITE	VIS	SCHRAUBE	SCREW	TE 12 x 35 UNI 5739		
21	60020400	6	VITE	VIS	SCHRAUBE	SCREW	TE 12 x 25 UNI 5739		
22	62010600	3	DADO	ECROU	MUTTER	NUT	M 12 x 1,75 AUTOBLOCC.		
23	40317800	1	CONTROTELAIO	FERMETURE	VERSCHLUSS	LOCK	105		
23	40317900	1	CONTROTELAIO	FERMETURE	VERSCHLUSS	LOCK	120		
23	40318000	1	CONTROTELAIO	FERMETURE	VERSCHLUSS	LOCK	140		
23	40318100	1	CONTROTELAIO	FERMETURE	VERSCHLUSS	LOCK	155		

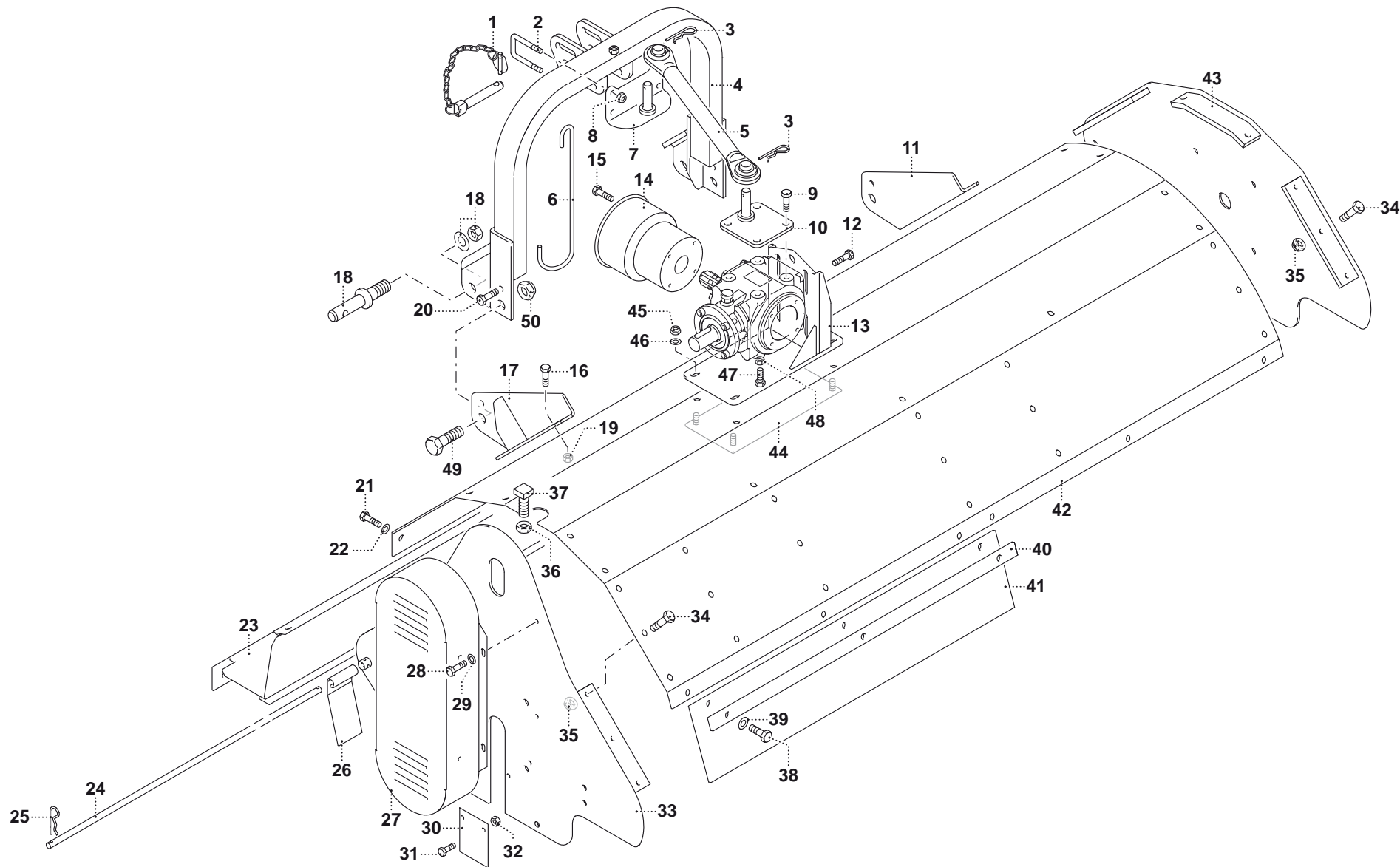

MURATORI MT 40

TAV. 1.0

POS.	N° CODICE	Q.	DESCRIZIONE	DESIGNATION	BENENNUNG	DESCRIPTION	DESIGNAZIONE	Da matr. De nr. serie Vom Seriennr. From serial nr.	Fino matr. Jusqu'au nr. serie Bis Seriennr. Up to serial nr.
23	40318200	1	CONTROTELAIO	FERMETURE	VERSCHLUSS	LOCK	170		
23	40318300	1	CONTROTELAIO	FERMETURE	VERSCHLUSS	LOCK	185		
23	40318400	1	CONTROTELAIO	FERMETURE	VERSCHLUSS	LOCK	200		
24	38028000	1	SPINA	GOUPILLE	STIFT	PIN	105		
24	38028100	1	SPINA	GOUPILLE	STIFT	PIN	120		
24	38028200	1	SPINA	GOUPILLE	STIFT	PIN	140		
24	38028300	1	SPINA	GOUPILLE	STIFT	PIN	155		
24	38028400	1	SPINA	GOUPILLE	STIFT	PIN	170		
24	38028500	1	SPINA	GOUPILLE	STIFT	PIN	185		
24	38028600	1	SPINA	GOUPILLE	STIFT	PIN	200		
25	64000300	1	COPIGLIA	COUPILLE	SPLINT	COTTER PIN	AR Ø 3		
26	39128400		BANDELLA	BANDE	BAND	STRAP	L=70		
26	39164100		BANDELLA	BANDE	BAND	STRAP	L=25		
26	39164200		BANDELLA	BANDE	BAND	STRAP	L=35		
26	39164300		BANDELLA	BANDE	BAND	STRAP	L=45		
27	40219001	1	CARTER	CARTER	KETTENKASTEN	CASING			
28	60022800	4	VITE	VIS	SCHRAUBE	SCREW	TE 8 x 20 UNI 5739		
29	61006200	4	RONDELLA	RONDELLE	SCHEIBE	WASHER	PIANA Øi 9 Øe 24 SP 1,5		
30	39340700	1	CHIUSURA	FERMETURE	VERSCHLUSS	GRIPPING			
31	60022800	2	VITE	VIS	SCHRAUBE	SCREW	TE 8 x 20 UNI 5739		
32	62010200	2	DADO	ECROU	MUTTER	NUT	M 8 x 1,25 AUTOBLOCC.		
33	40319200	1	FIANCO SX	FLANC (G)	SEITENWAND (LINKS)	SIDE FRAME (LH)			131652
33	40324700	1	FIANCO SX	FLANC (G)	SEITENWAND (LINKS)	SIDE FRAME (LH)		131653	
34	60044400		VITE	VIS	SCHRAUBE	SCREW	TE 12 x 20 UNI 5739		
35	61011300		RONDELLA	RONDELLE	SCHEIBE	WASHER			
36	62014500	1	DADO	ECROU	MUTTER	NUT	M 20 x 2,5 UNI 5589		

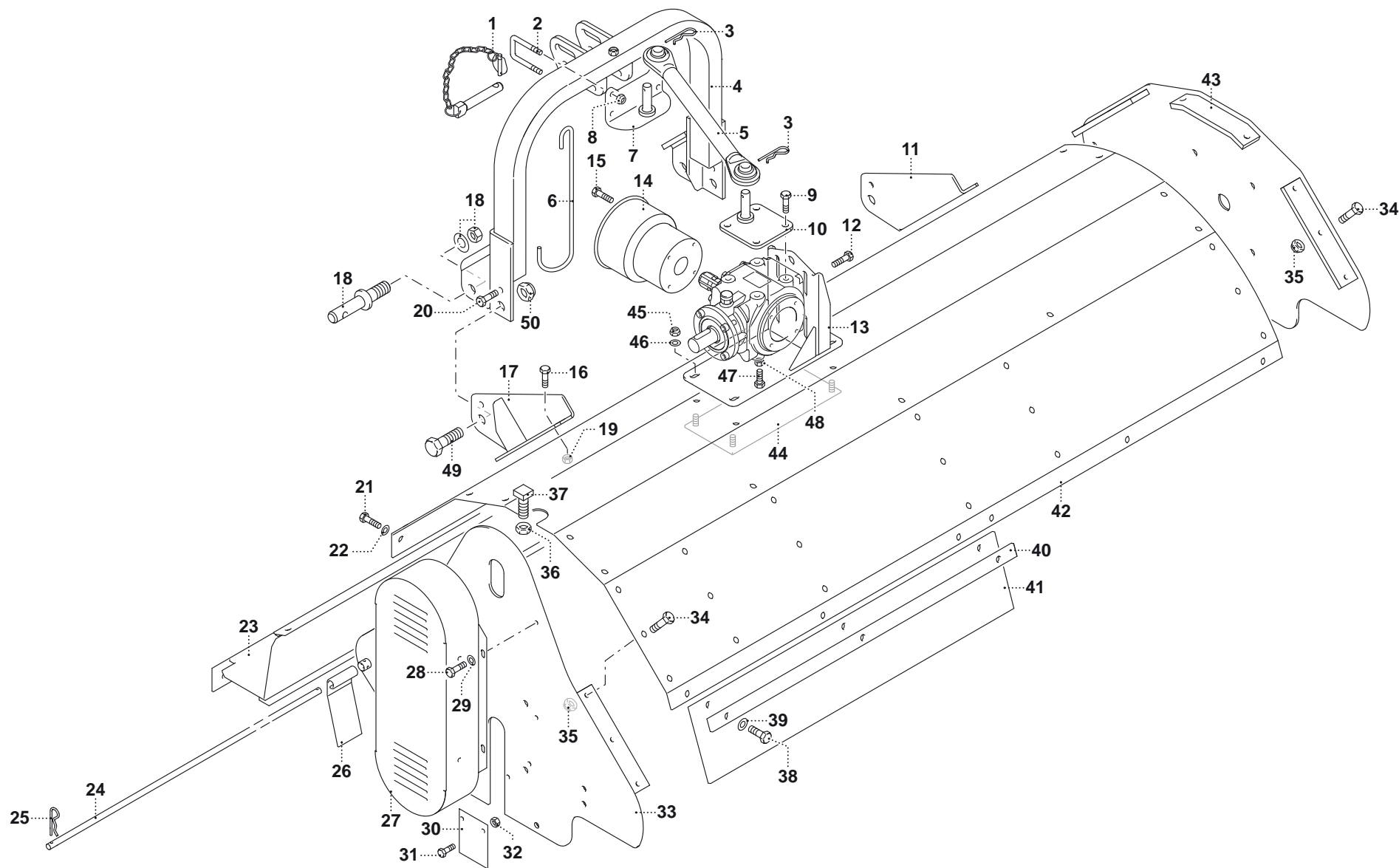

MURATORI MT 40

TAV. 1.0

POS.	N° CODICE	Q.	DESCRIZIONE	DESIGNATION	BENENNUNG	DESCRIPTION	DESIGNAZIONE	Da matr. De nr. serie Vom Seriennr. From serial nr.	Fino matr. Jusqu'au nr. serie Bis Seriennr. Up to serial nr.
37	60010800	1	VITE	VIS	SCHRAUBE	SCREW	TE 20 x 60 UNI 5739		
38	60021200		VITE	VIS	SCHRAUBE	SCREW	TE 12 x 35 UNI 5739		
39	62010600		DADO	ECROU	MUTTER	NUT	M 12 x 1,75 AUTOBLOCC.		
40	30213100	2	PIATTO	PLAQUE	PLATTE	DISC	105		
40	30213200	2	PIATTO	PLAQUE	PLATTE	DISC	120		
40	30213300	2	PIATTO	PLAQUE	PLATTE	DISC	140		
40	30213400	2	PIATTO	PLAQUE	PLATTE	DISC	155		
40	30213500	2	PIATTO	PLAQUE	PLATTE	DISC	170		
40	30213600	2	PIATTO	PLAQUE	PLATTE	DISC	185		
40	30213700	2	PIATTO	PLAQUE	PLATTE	DISC	200		
41	68121700	2	BANDELLA	BANDE	BAND	STRAP	105		
41	68121800	2	BANDELLA	BANDE	BAND	STRAP	120		
41	68121900	2	BANDELLA	BANDE	BAND	STRAP	140		
41	68122000	2	BANDELLA	BANDE	BAND	STRAP	155		
41	68122100	2	BANDELLA	BANDE	BAND	STRAP	170		
41	68122200	2	BANDELLA	BANDE	BAND	STRAP	185		
41	68122300	2	BANDELLA	BANDE	BAND	STRAP	200		
42	39335600	1	TELAIO	CHASSIS	RAHMEN	FRAME	105		
42	39335700	1	TELAIO	CHASSIS	RAHMEN	FRAME	120		
42	39335800	1	TELAIO	CHASSIS	RAHMEN	FRAME	140		
42	39335900	1	TELAIO	CHASSIS	RAHMEN	FRAME	155		
42	39336000	1	TELAIO	CHASSIS	RAHMEN	FRAME	170		
42	39336100	1	TELAIO	CHASSIS	RAHMEN	FRAME	185		
42	39336200	1	TELAIO	CHASSIS	RAHMEN	FRAME	200		
43	40319300	1	FIANCO DX	FLANC (D)	SEITENWAND (RECHTS)	SIDE FRAME (RH)			131652
43	40324800	1	FIANCO DX	FLANC (D)	SEITENWAND (RECHTS)	SIDE FRAME (RH)		131653	

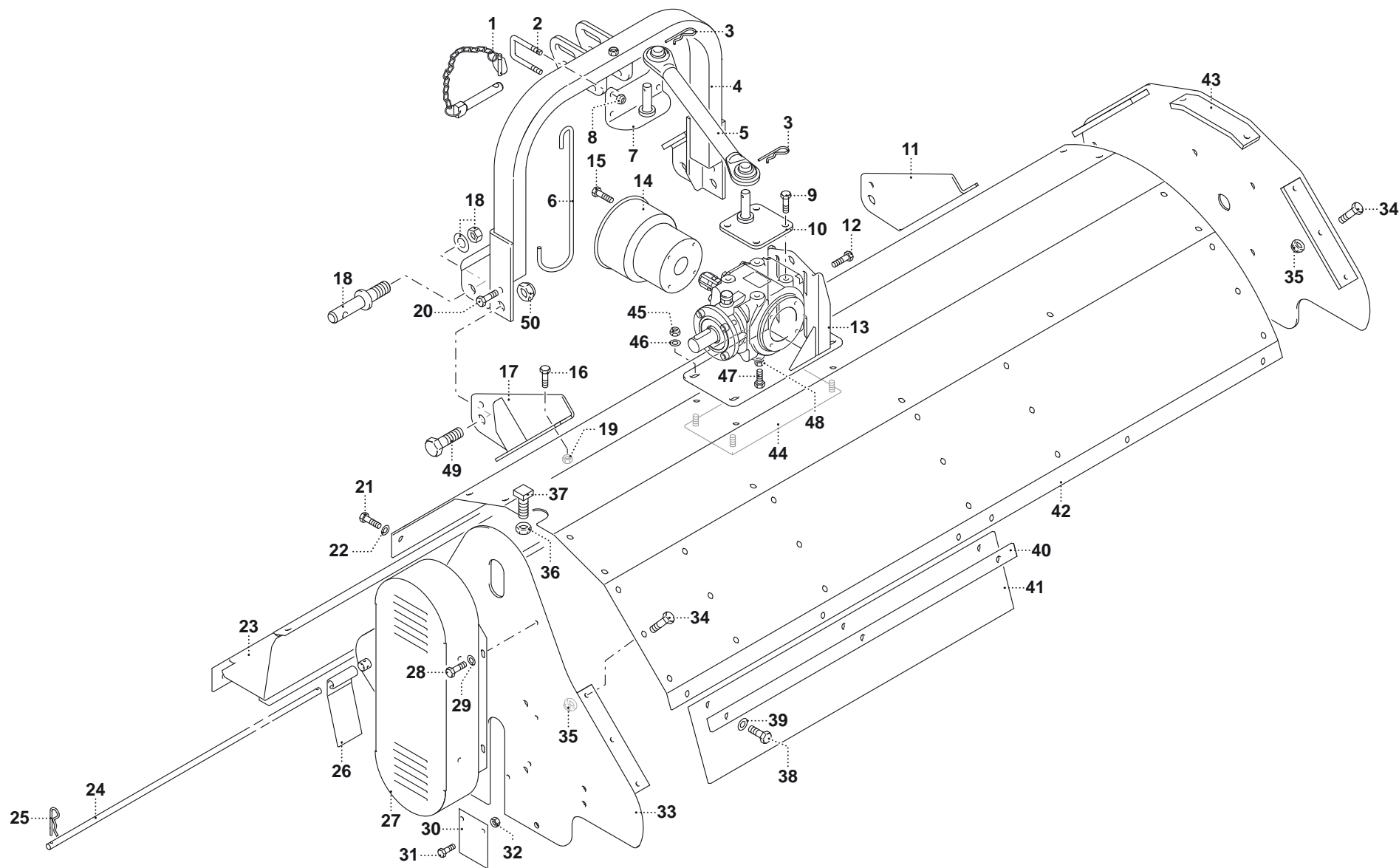

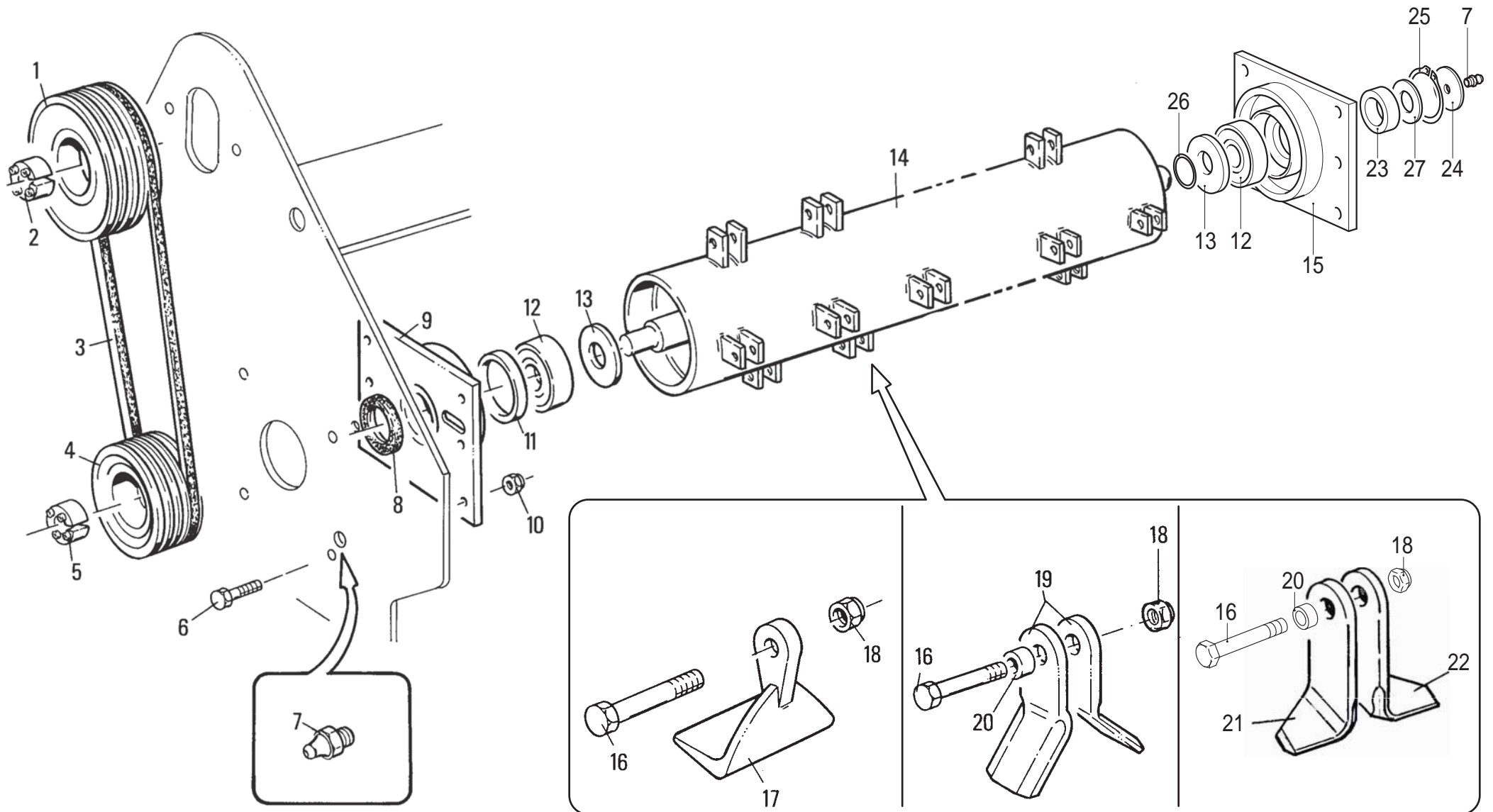

MURATORI MT 40

TAV. 2.0

POS.	N° CODICE	Q.	DESCRIZIONE	DESIGNATION	BENENNUNG	DESCRIPTION	DESIGNAZIONE	Da matr. De nr. serie Vom Seriennr. From serial nr.	Fino matr. Jusqu'au nr. serie Bis Seriennr. Up to serial nr.
1	68059300	1	PULEGGIA	POULIE	RIEMENSCHLEIBE	PULLEY	Ø 160 2 SPB (105)		
1	68059600	1	PULEGGIA	POULIE	RIEMENSCHLEIBE	PULLEY	Ø 160 3 SPB (120-140)		
1	68113900	1	PULEGGIA	POULIE	RIEMENSCHLEIBE	PULLEY	Ø 160 4 SPB (155-200)		
2	68084100	1	CALETTATORE	DOUILLE DE SERRAGE	SPANNBUCHSE	LOCKING DEVICE	Øe 65 Øi 35		
3	68084900		CINGHIA	COURROIE	KEILRIEMEN	BELT	B 46		
4	68079200	1	PULEGGIA	POULIE	RIEMENSCHLEIBE	PULLEY	Ø 120 2 SPB (105)		
4	68079300	1	PULEGGIA	POULIE	RIEMENSCHLEIBE	PULLEY	Ø 120 3 SPB (120-140)		
4	68082400	1	PULEGGIA	POULIE	RIEMENSCHLEIBE	PULLEY	Ø 120 4 SPB (155-200)		
5	68059500	1	CALETTATORE	DOUILLE DE SERRAGE	SPANNBUCHSE	LOCKING DEVICE	Øe 65 Øi 40		
6	60026700	8	VITE	VIS	SCHRAUBE	SCREW	TE 14x30 UNI 5739		
7	64001800	2	INGRASSATORE	GRAISSEUR	SCHMIERNIPPEL	GREASE FITTING	M10 x 1		
8	66014100	1	ANELLO TENUTA	JOINT D'ETANCHEITE	DICHTUNGSRING	JUNT RING	45 x 55 x 6 "G"		
9	40218600	1	SUPPORTO SX	SUPPORT (G)	HALTER (LINKS)	SUPPORT (LH)			131652
9	40324600	1	SUPPORTO SX	SUPPORT (G)	HALTER (LINKS)	SUPPORT (LH)		131653	
10	62010800	8	DADO	ECROU	MUTTER	NUT	M 14 x 2 AUTOBLOCC.		
11	68011000	1	SPESSORE	EPAISSEUR	BEILAGERING	SPACER	55 x 45 x 1		
12	67018200	2	CUSCINETTO	ROULEMENT	LAGER	BEARING	2209		
13	39237400	2	PROTEZIONE	PROTECTION	SCHUTZ	GUARD			
14	42064300	1	ROTORE	ROTOR	ROTOR	ROTOR	105		
14	42064400	1	ROTORE	ROTOR	ROTOR	ROTOR	120		
14	42064500	1	ROTORE	ROTOR	ROTOR	ROTOR	140		
14	42064600	1	ROTORE	ROTOR	ROTOR	ROTOR	155		
14	42064700	1	ROTORE	ROTOR	ROTOR	ROTOR	170		
14	42064800	1	ROTORE	ROTOR	ROTOR	ROTOR	185		
14	42084100	1	ROTORE	ROTOR	ROTOR	ROTOR	200		
15	40218500	1	SUPPORTO DX	SUPPORT (D)	HALTER (RECHTS)	SUPPORT (RH)			131652

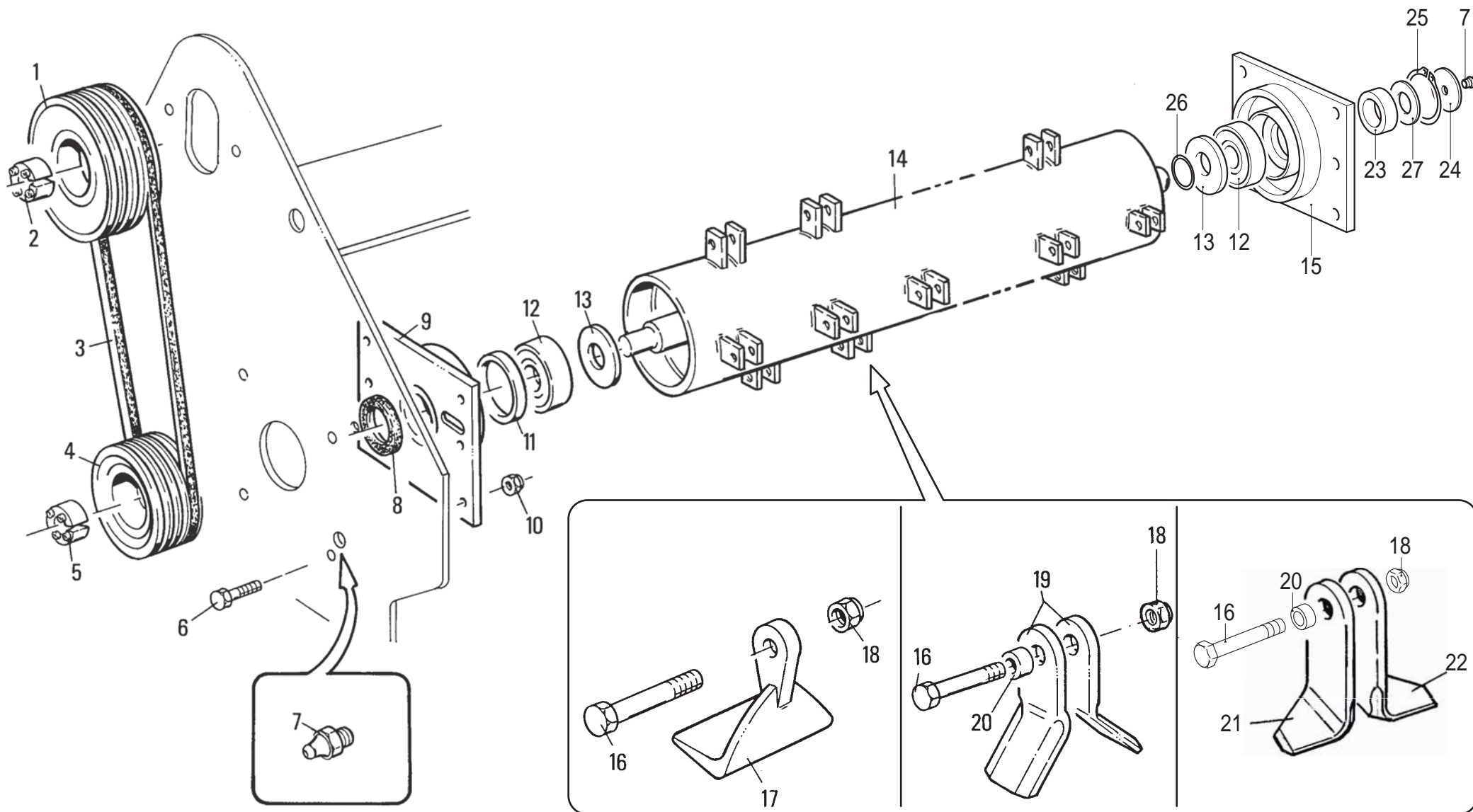

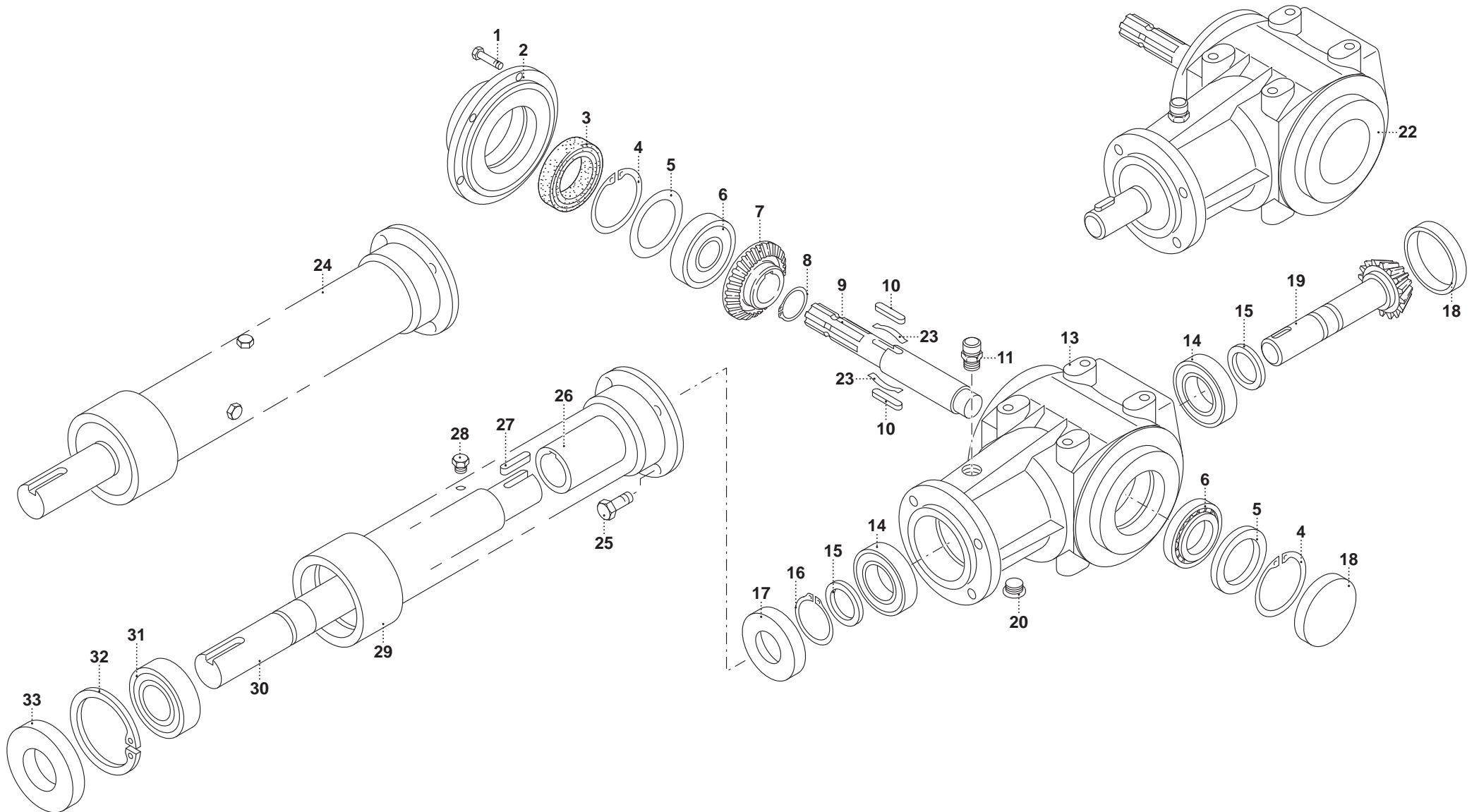

MURATORI MT 40

TAV. 3.0

POS.	N° CODICE	Q.	DESCRIZIONE	DESIGNATION	BENENNUNG	DESCRIPTION	DESIGNAZIONE	Da matr. De nr. serie Vom Seriennr. From serial nr.	Fino matr. Jusqu'au nr. serie Bis Seriennr. Up to serial nr.
1	60021600	8	VITE	VIS	SCHRAUBE	SCREW	TE 10x20 UNI 5739		
2	01020000	1	COPERCHIO	COUVERCLE	DECKEL	COVER			
3	66001400	1	ANELLO TENUTA	JOINT D'ETANCHEITE	DICHTUNGSRING	JUNT RING	35x80x10		
4	63000200	2	ANELLO ELASTICO	ARRETOIR	SPANNRING	SNAP-RING	Øi 80 UNI 7437		
5	68075500		SPESSORE	EPAISSEUR	DISTANZRING	SPACER	80x70		
6	67002100	2	CUSCINETTO	ROULEMENT	LAGER	BEARING	6307		
7	10050000	1	CORONA	COURONNE	KRANZ	CROWN			
8	63005000	1	ANELLO ELASTICO	ARRETOIR	SPANNRING	SNAP-RING	Øe 42 UNI 7435		
9	31097000	1	ALBERO	ARBRE	WELLE	SHAFT			
10	65002600	2	LINGUETTA	CLAVETTE	FEDER	KEY			
11	68085600	1	TAPPO	BOUCHON	STOPFEN	PLUG	3/8		
12	68111900	1	GOMITO	COUDE	WINKELSTÜCK	BBEND			
13	01020100	1	SCATOLA	CARTER	GEHAEUSE	GEARBOX			
14	67000300	2	CUSCINETTO	ROULEMENT	LAGER	BEARING	30207		
15	68052300		SPESSORE	EPAISSEUR	DISTANZRING	SPACER	48x35		
16	63006900	1	ANELLO ELASTICO	ARRETOIR	SPANNRING	SNAP-RING	Øe 35 UNI 7436		
17	66014800	1	ANELLO TENUTA	JOINT D'ETANCHEITE	DICHTUNGSRING	JUNT RING	35x72x10		
18	68067300	2	CAPPELOTTO	BOUCHON	ABSCHLUSSKAPPE	CAP NUT			
19	10050100	1	ALBERO	ARBRE	WELLE	SHAFT			
20	68008700	1	TAPPO	BOUCHON	STOPFEN	PLUG	3/8		
21	68085600	1	TAPPO	BOUCHON	STOPFEN	PLUG			
22	46039600	1	MOLTIPLICATORE	MULTIPLICATEUR	GETRIEBE	GEAR BOX			
23	68085400	2	MOLLA	RESSORT	FEDER	SPRING			
24	45177200	2	PROLUNGA COMPLETA	RALLONGE COMPLETE	KOMPLETTVERLÄNGERUNGSROHR	COMPLETE EXTENSION	105-140		
24	45177300	2	PROLUNGA COMPLETA	RALLONGE COMPLETE	KOMPLETTVERLÄNGERUNGSROHR	COMPLETE EXTENSION	155-185		
24	45177400	2	PROLUNGA COMPLETA	RALLONGE COMPLETE	KOMPLETTVERLÄNGERUNGSROHR	COMPLETE EXTENSION	200		

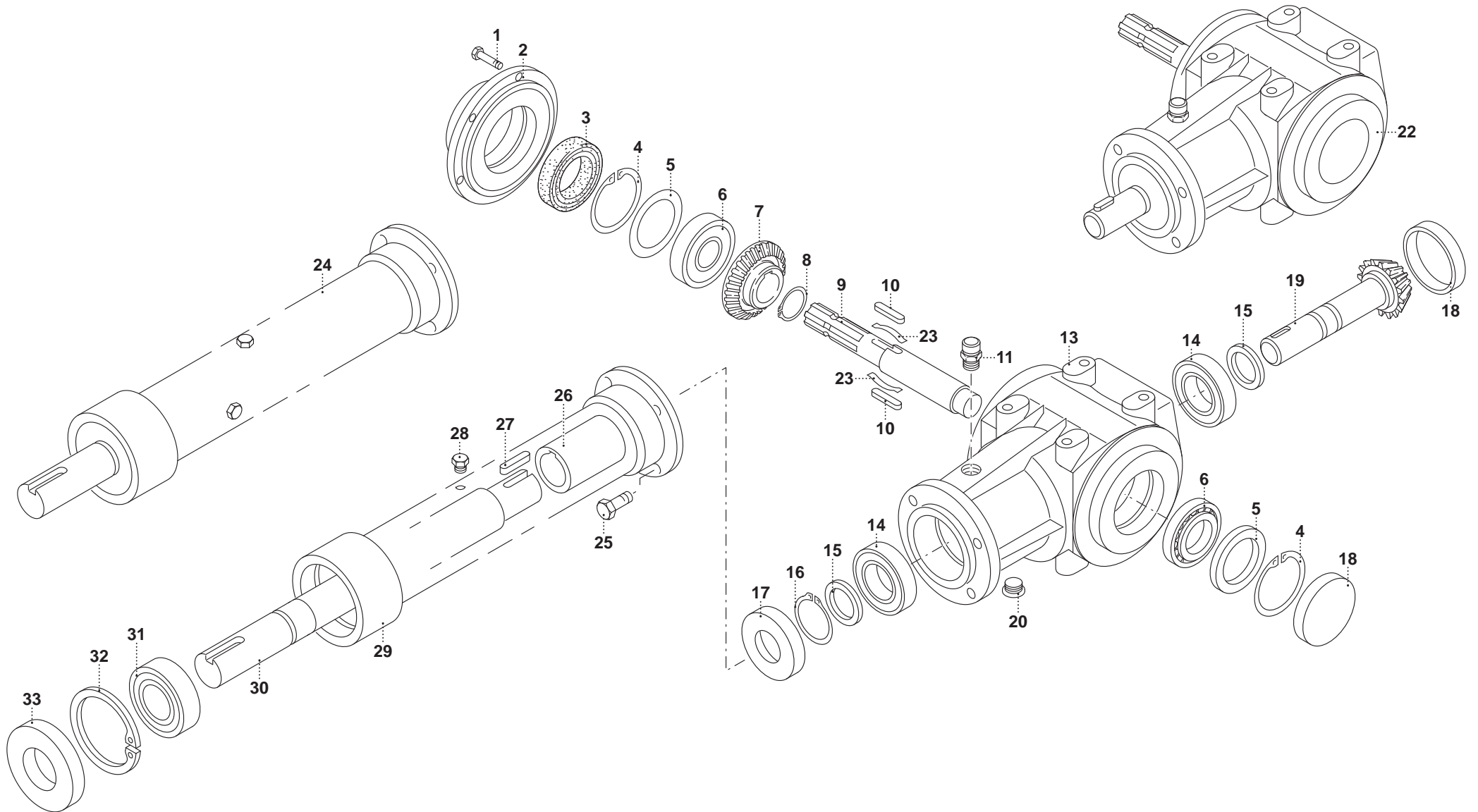

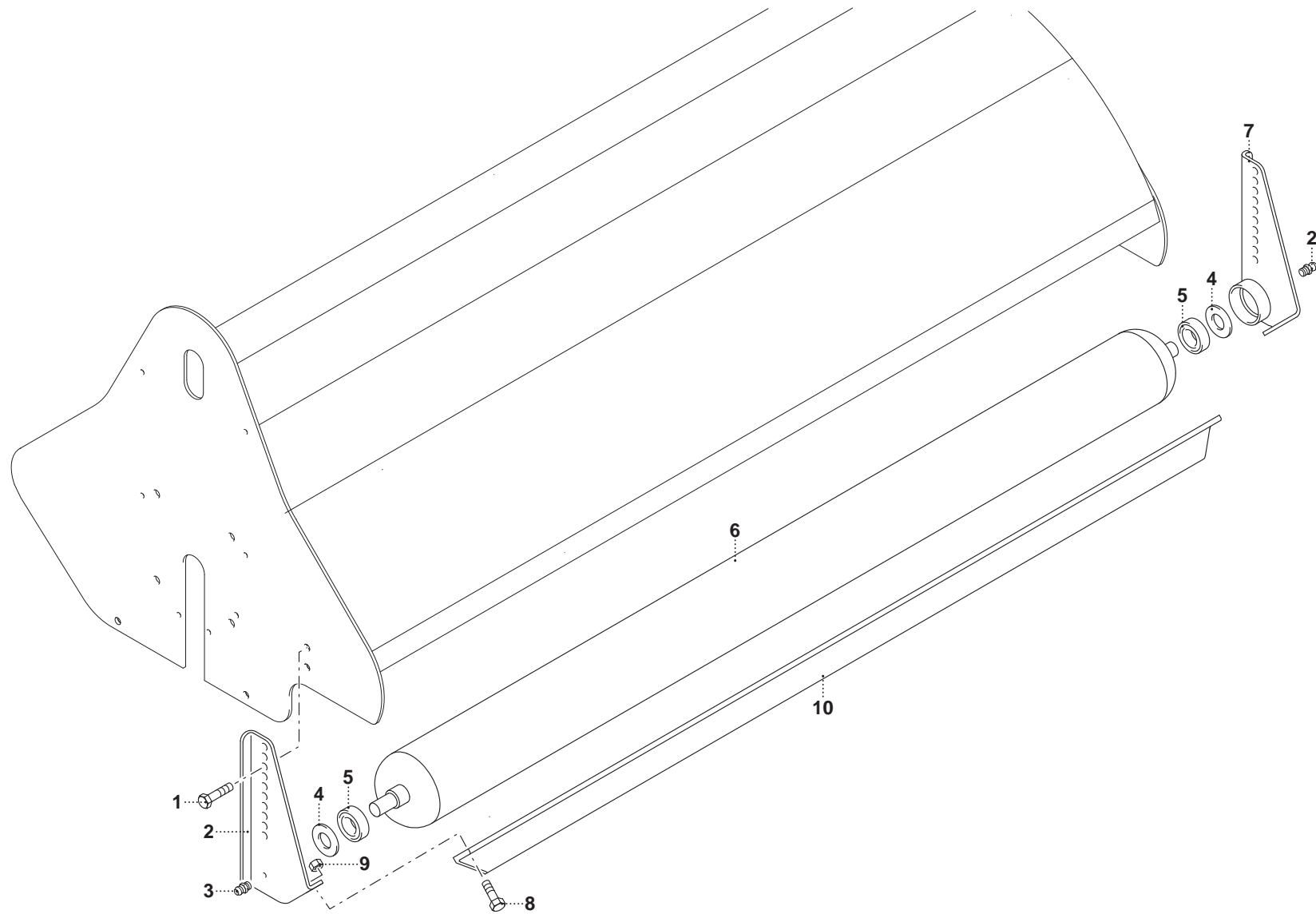

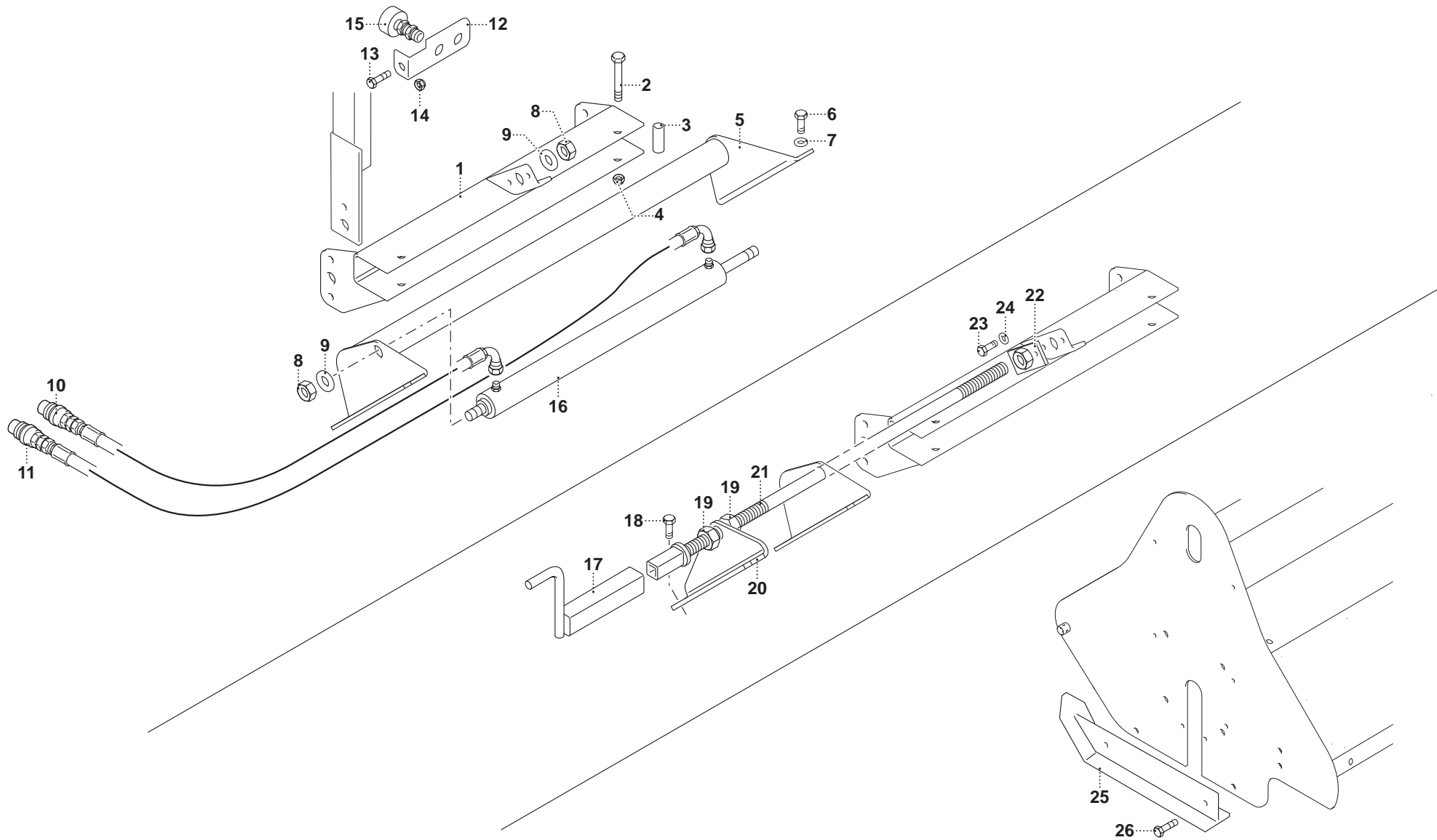

MURATORI MT 40

TAV. 5.0

POS.	N° CODICE	Q.	DESCRIZIONE	DESIGNATION	BENENNUNG	DESCRIPTION	DESIGNAZIONE	Da matr. De nr. serie Vom Seriennr. From serial nr.	Fino matr. Jusqu'au nr. serie Bis Seriennr. Up to serial nr.
1	40267900	1	CARRELLO	CHARIOT	WAGEN	CAR			
2	60021500	2	VITE	VIS	SCHRAUBE	SCREW	TE 12 x 80 UNI 5737		
3	32183700	2	DISTANZIALE	ENTRETOISE	DISTANZSTÜCK	SPACER			
4	62010600	2	DADO	ECROU	MUTTER	NUT	M 12 x 1,75 AUTOBLOCC.		
5	40320100	1	TELAIO	CHASSIS	RAHMEN	FRAME			
6	60023000	6	VITE	VIS	SCHRAUBE	SCREW	TE 12 x 30 UNI 5739		
7	61005000	6	RONDELLA	RONDELLE	SCHEIBE	WASHER	PIANA Ø 12 UNI 6592		
8	62008300	2	DADO	ECROU	MUTTER	NUT	M 20 UNI 5588		
9	61005800	2	RONDELLA	RONDELLE	SCHEIBE	WASHER	PIANA Ø 20 UNI 6592		
10	68048300	1	TUBO	TUBE	ROHR	TUBE			
11	68048400	1	TUBO	TUBE	ROHR	TUBE			
12	39336800	1	SUPPORTO	SUPPORT	HALTERUNG	SUPPORT			
13	60023000	1	VITE	VIS	SCHRAUBE	SCREW	TE 12 x 30 UNI 5739		
14	62010600	1	DADO	ECROU	MUTTER	NUT	M 12 x 1,75 AUTOBLOCC.		
15	68123100	2	INNESTO FEMMINA	ENCLENCHEMENT FEMME	WEIB KUPPLUNG	FEMALE ENGAGEMENT			
16	68083800	1	CILINDRO	CYLINDRE	ZYLINDER	CYLINDER			
17	40121700	1	MANOVELLA	MANIVELLE	KURBEL	CRANK			
18	60023000	2	VITE	VIS	SCHRAUBE	SCREW	TE 12 x 30		
19	62014700	2	CHIOCCIOLA	ECROU EN CARACOLE	MUTTERSCHLOSS	LEAD NUT			
20	39337000	1	AGGANCI	CROCHET	HAKEN	HOOK			
21	40247000	1	VITE	VIS	SCHRAUBE	SCREW			
22	40246800	1	CHIOCCIOLA	ECROU EN CARACOLE	MUTTERSCHLOSS	LEAD NUT			
23	60036200	2	VITE	VIS	SCHRAUBE	SCREW	TE 8 x 35 UNI 5739		
24	62010200	2	DADO	ECROU	MUTTER	NUT	M 8 x 1,25 AUTOBLOCC.		
25	40219100	2	SLITTA	PATIN	STUTZKUF	SKID			
26	60023000	4	VITE	VIS	SCHRAUBE	SCREW	TE 12 x 30 UNI 5739		

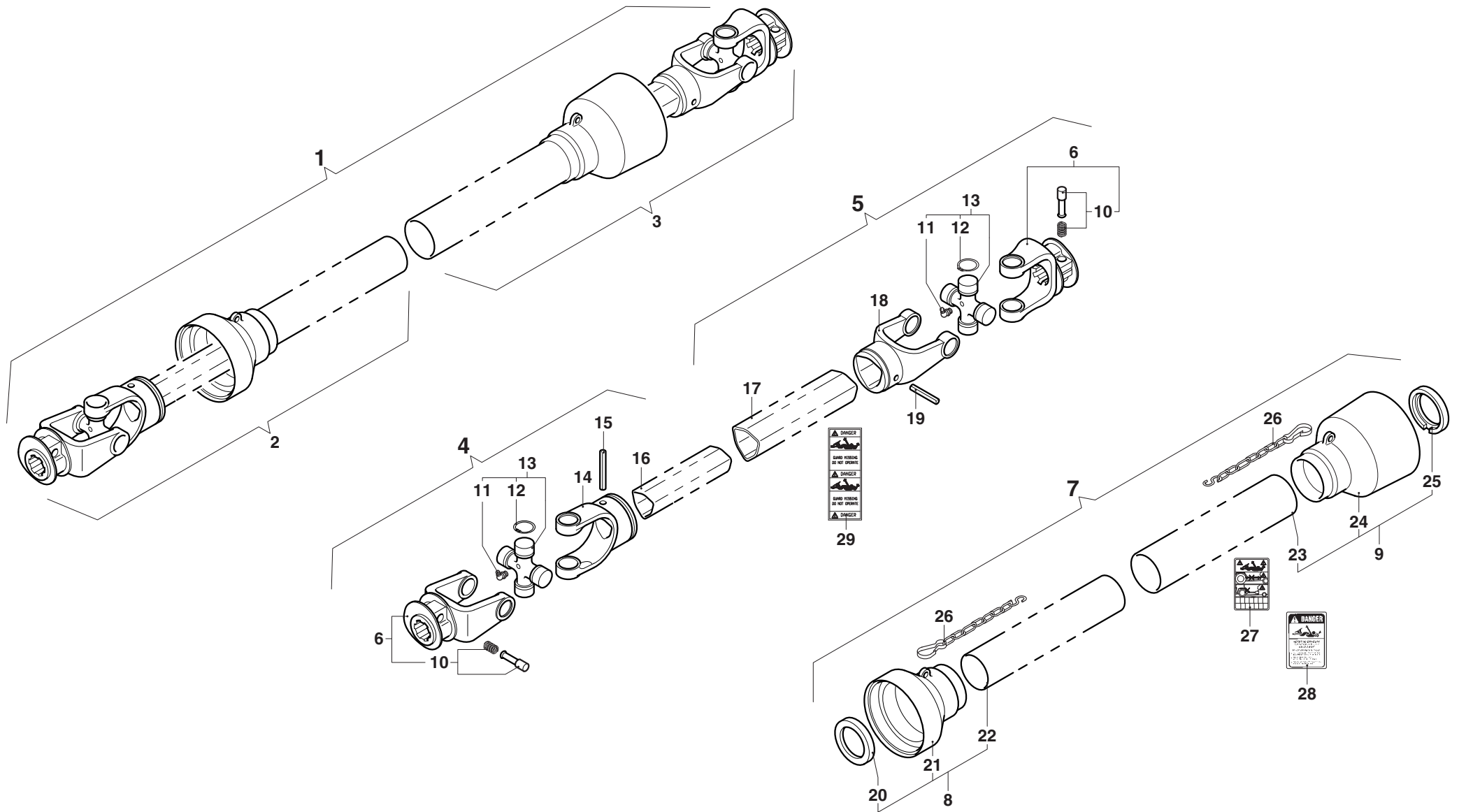

MURATORI MT 40

TAV. 6.0

POS.	N° CODICE	Q.	DESCRIZIONE	DESIGNATION	BENENNUNG	DESCRIPTION	DESIGNAZIONE	Da matr. De nr. serie Vom Seriennr. From serial nr.	Fino matr. Jusqu'au nr. serie Bis Seriennr. Up to serial nr.
1	AB409SF	1	ALBERO CARDANICO COMPLETO	ARBRE A JOINTS DE CARDAN	KARDANWELLE	PTO SHAFT			
2	B4090B1	1	SEMIALBERO INTERNO	DEMI-ARBRE INTERIEUR	INNENHALBWELLE	INTERNAL HALF SHAFT			
3	B4090B2	1	SEMIALBERO ESTERNO	DEMI-ARBRE EXTERIEUR	AUSSENHALBWELLE	EXTERNAL HALF SHAFT			
4	B409001	1	SEMIALBERO INTERNO	DEMI-ARBRE INTERIEUR	INNENHALBWELLE	INTERNAL HALF SHAFT			
5	B409002	1	SEMIALBERO ESTERNO	DEMI-ARBRE EXTERIEUR	AUSSENHALBWELLE	EXTERNAL HALF SHAFT			
6	0800403	2	FORCELLA	FOURCHE	GABEL	YOKE			
7	083B04090	1	PROTEZIONE	PROTECTION	SCHUTZ	GUARD			
8	083B040901	1	PROTEZIONE INTERNA	PROTECTION INTERIEURE	INNENSCHUTZ	INTERNAL GUARD			
9	083B040902	1	PROTEZIONE ESTERNA	PROTECTION EXTERIEURE	AUSSENSCHUTZ	EXTERNAL GUARD			
10	0986014047	2	PULSANTE	BOUTON	DRUCKKNOPF	PUSH BOTTON			
11	09840081002	2	INGRASSATORE	GRAISSEUR	SCHMIERNIPPEL	GREASE FITTING			
12	09802027	8	ANELLO ELASTICO	ARRETOIR	SPANNRING	SNAP-RING			
13	08204	2	CROCIERA	CROISILLON	KREUZSTÜCK	SPIDER			
14	08004011	1	FORCELLA	FOURCHE	GABEL	YOKE			
15	098700855	1	SPINA ELASTICA	GOUPILLE ELASTIQUE	SPANNSTIFT	ELASTIC PIN			
16	09881364100	1	TUBO INTERNO	TUBE INTERIEUR	INNENROHR	INTERNAL TUBE			
17	09881433100	1	TUBO ESTERNO	TUBE EXTERIEUR	AUSSENROHR	EXTERNAL TUBE			
18	08004021	1	FORCELLA	FOURCHE	GABEL	YOKE			
19	098700860	1	SPINA ELASTICA	GOUPILLE ELASTIQUE	SPANNSTIFT	ELASTIC PIN			
20	0265240008	1	GHIERA	FRETTE	NUTMUTTER	RING NUT			
21	0256040425	1	CUFFIA	CAPOUCHON	HAUBE	GUARD			
22	0988961B4090	1	TUBO INTERNO	TUBE INTERIEUR	INNENROHR	INTERNAL TUBE			
23	0988966B4090	1	TUBO ESTERNO	TUBE EXTERIEUR	AUSSENROHR	EXTERNAL TUBE			
24	0256040424	1	CUFFIA	CAPOUCHON	HAUBE	GUARD			
25	0265240007	1	GHIERA	FRETTE	NUTMUTTER	RING NUT			

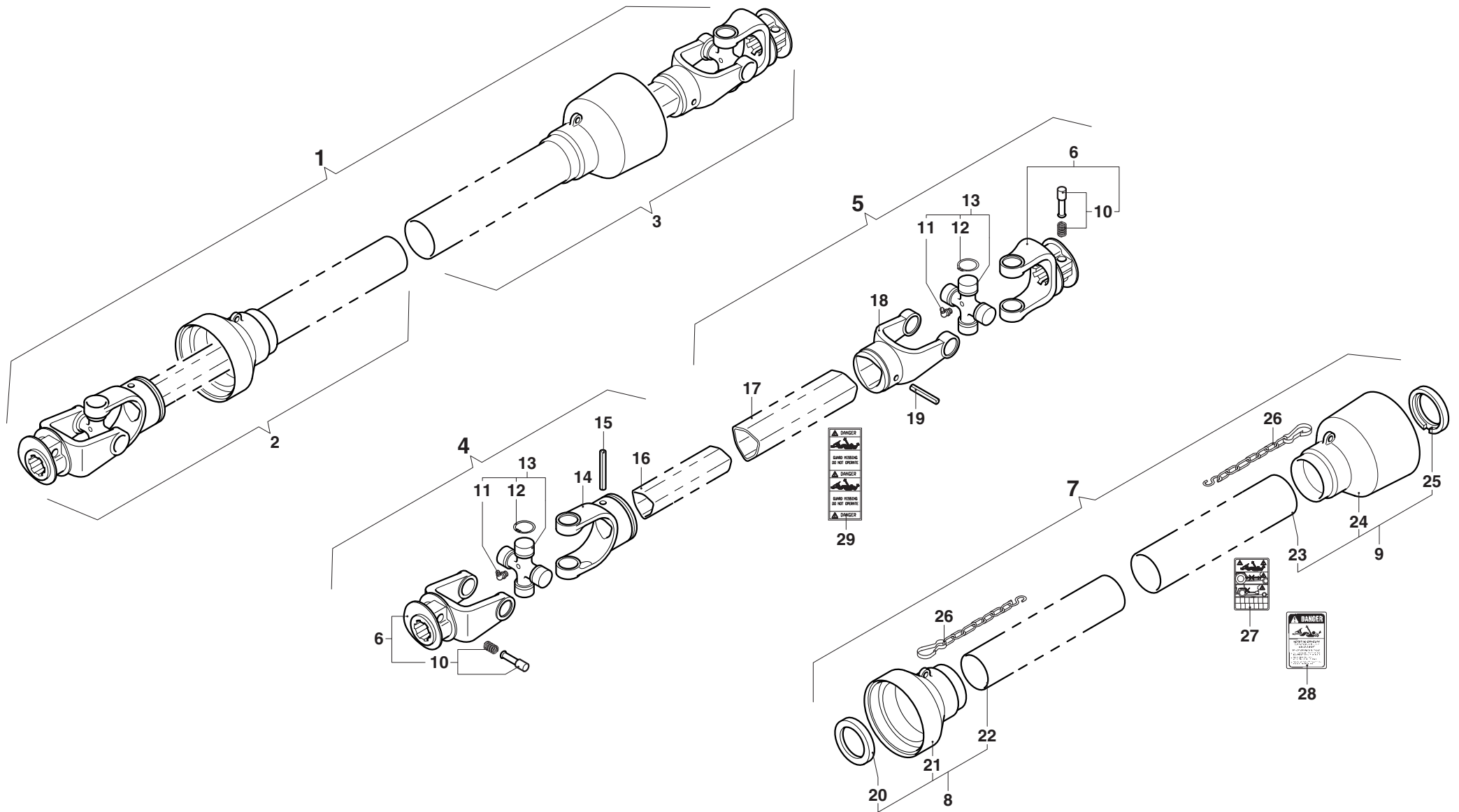



MURATORI S.p.A.

Via Pavarello, 21 - 41051 Castelnuovo Rangone (MO) Italy - Tel. 059.5330611 Fax 059.537259

www.muratoriequip.it *info@muratoriequip.it*

Capitale sociale Euro 480.000 interamente versato

Registro Imprese di Modena

Codice fiscale e numero d'iscrizione: 00708860366