



MURATORI

MTL2-MTL5

Trinciatrice laterale - Flail mower
Broyeur d'accotement - Mulchgeräte



RELIABILITY AND PROFESSIONALISM

MTL2

TRINCIATRICE LATERALE

Trinciatrice dotata di braccio estensibile può lavorare con grande disassamento e svariate angolazioni. È l'ideale per l'uso in parchi, giardini, e spazi verdi in genere. Robusta e versatile, non ha un peso eccessivo così da poter essere utilizzata anche su trattorini di potenza limitata.

EQUIPAGGIAMENTO DI SERIE:

- Cardano
- Sicurezza e autolivellamento con bielletta
- Protezione anteriore
- Rullo posteriore
- Spostamento laterale idraulico ed inclinazione idraulica
- Moltiplicatore per PTO 540 giri/min. con ruota libera interna
- Slitte saldate.

A RICHIESTA:

- Cardano doppio omocinetico (non disponibile sul cm 105)



FLAIL MOWER

Thanks to its extensible arms, this flail mower can work in extreme offset position and in various different angles, it is ideal for the use in green areas (like parks, gardens etc.). Strong and versatile, it is not excessively heavy so to suit also small tractors.

STANDARD EQUIPMENT

- Standard drive line
- Safety and self levelling breakway coupling
- Front safety protection
- Rear roller
- Hydraulic side adjustment and hydraulic inclination adjustment
- Gear box for PTO 540 RPM with free wheel inside
- Skids welded on main frame.

OPTIONS:

- Double wide angle drive line (not available on cm 105)

BROYEUR

Broyeur doué d'un bras extensible, il peut travailler avec grand déport et plusieurs angles. C'est l'idéal pour l'emploi dans les parcs, les jardins et les espaces verts en général. Robuste et életronique il a un poids limité tel qu'il peut être utilisé même sur des petits tracteurs de puissance limitée.

DOTATION STANDARD

- Cardan
- Sécurité et auto-nivellement avec biellette
- Protection avant
- Rouleau arrière
- Déport latérale hydraulique et inclinaison hydraulique
- Boîtier pour PTO 540 tour/min et roue libre à l'intérieur
- Patins soudés.

OPTIONS:

- Cardan double homocinétique (pas disponible sur cm 105)

MULCHGERÄT

Dank dem ausdehnbarem Arm kann das Mulchgerät in großer außerachsiger Position und in verschiedenen Abwinklungen arbeiten. Diese Maschine kann am besten auf Parken, Garden, Grünerflächen benutzt werden. Kräftig und vielseitig, erlaubt sein geringstes Gewicht einen Gebrauch auf Schlepper mit kleiner Leistung.







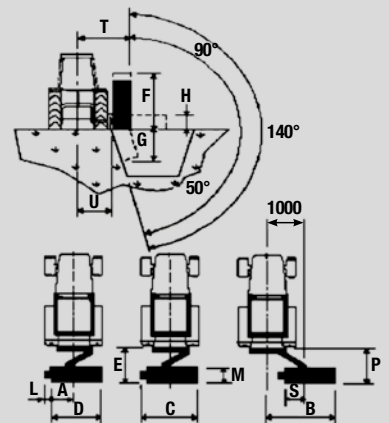

STANDARDAUSSTATTUNG:

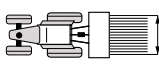
- Zapfwelle 540 U/min
- Gelenkwelle
- Anfahrtssicherung und Bodenangleich durch Pleuelstange
- Vordere Schutz
- Walze
- Hydraulische Seitenverschiebung
- Hydraulische Neigung
- Getriebe mit Freilauf - Kufen.

SONDERAUSSTATTUNG:

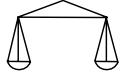
- Zweiseitiges Weitwinkelgelenkwelle (Nicht vorrätig auf cm 105)



MODELS			 HP - CV - PS								 Kg			
	cm	inch	MED	MAX	n.	n.	Kg	LBS	RPM/UPM	RPM	MIN	MIN		
MTL2-105	105	41	20	35	48	24	215	469	540	3078	100	650		
MTL2-130	130	51	20	35	64	32	232	506	540	3078	110	700		
MTL2-155	154	61	25	35	80	40	255	556	540	3078	120	800		
MODELS	Dati tecnici - Technische Daten - Technical data - Données techniques													
	A cm	B cm	C cm	D cm	E cm	F cm	G cm	H cm	L cm	M cm	P cm	S cm	T cm	U cm
MTL2-105	72	161	113	105	104	113	80	32	8	52	130	47	123	73
MTL2-130	72	186	140	132	104	140	105	32	8	52	130	47	123	73
MTL2-155	72	209	163	155	104	163	128	32	8	52	130	47	123	73

MTL5

TRINCIATRICE LATERALE

Robusta trinciatrice con braccio laterale. È adatta alle più svariate operazioni come la pulizia di fossati, di sponde di canali e di banchine stradali.

EQUIPAGGIAMENTO DI SERIE:

- Cardano
- Protezioni anteriori
- Rullo posteriore
- Inclinazione idraulica
- Spostamento laterale idraulico
- Moltiplicatore per PTO 540 giri/min. con ruota libera interna
- Cuscinetti del rotore oscillanti con doppia corona di sfere
- Rotore con coltelli universali o a mazze
- Catarifrangenti.

A RICHIESTA:

- Slitte, cardano doppio omocinetico, dispositivo oleodinamico antiurto.



FLAIL MOWER

Heavy-duty side arm flail mower. Ideal for maintenance of ditches, canal sideboards and road sides.

STANDARD EQUIPMENT

- Standard driveline
- Front safety protections
- Rear roller
- Hydraulic inclination adjustment
- Hydraulic side adjustment
- Gearbox at PTO 540 RPM and free wheel inside
- Oscillating bearings with double row-ball mounted on rotor
- Rotor with "Y" knives or hammers - Reflectors

OPTIONS:

- Side skids, Double wide angle driveline, Antishock oil-pressure device.

BROYEUR

Robuste broyeur d'accotement. Il est apte aux opérations comme le nettoyage de fossés, de bords de canaux et de routes.

DOTATION STANDARD

- Cardan
- Protections avant
- Rouleau arrière
- Inclinación hidráulica
- Deport lateral hidráulico
- Boîtier à 540 tours/min et roue libre à l'intérieur
- Rotor avec roulements flottants
- Rotor à couteaux ou à marteaux
- Catadioptrés

OPTIONS:

- Patins d'appui, Cardan double homocinétique, Dispositif oleopneumatique anti-choc.

MULCHGERÄT

Starkes Seitenmulcher mit ausdehnbarem Arm. Es ist für Einsätze geeignet wie z.B. Reinigung von Gräben, Böschungen und Straßenränder.







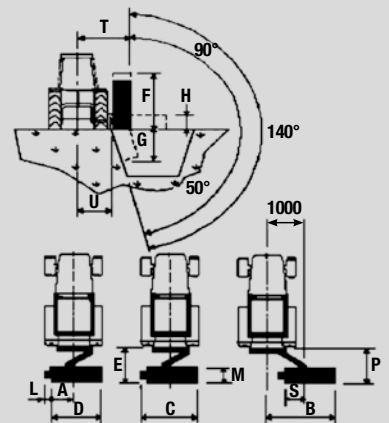

STANDARD AUSSTATTUNG:

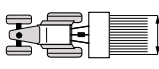
- Gelenkwelle
- Vordere Schutze
- Hintere Walze
- Hydraulische Neigung
- Seitliche und hydraulische Verschiebung
- Getriebe bei 540 UpM und Freilauf
- Rotor mit Pendellagern
- Rotor mit "Y" Messern oder mit Hämmern
- Rückstrahler.

SONDERAUSSTATTUNG:

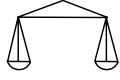
- Stutzkufen, Zweiseitiges Weitwinkelgelenkwelle, Hydro-pneumatische Anfahrtsicherung.



MODELS			 HP - CV - PS									 Kg		
	cm	inch	MED	MAX	n.	n.	Kg	LBS	RPM/UPM	RPM	MIN	MIN		
MTL5-135	135	53	25	40	24	12	540	2300	490	1068	160	2100		
MTL5-165	162	64	30	50	32	16	540	2300	510	1112	170	2200		
MTL5-200	192	79	35	60	40	20	540	2300	525	1144	180	2400		
MODELS	Dati tecnici - Technische Daten - Technical data - Données techniques													
	A cm	B cm	C cm	D cm	E cm	F cm	G cm	H cm	L cm	M cm	P cm	S cm	T cm	U cm
MTL5-135	85	180	151	135	161	220	95	44	16	71	193	47	150	90
MTL5-165	85	210	178	162	161	247	122	44	16	71	193	47	150	90
MTL5-200	85	237	208	192	161	277	152	44	16	71	193	47	150	90



MURATORI

MTL2-MTL5

Trinciatrice laterale - Flail mower
Broyeur d'accotement - Mulchgeräte



Via Pavarello, 21-21/ABC
41051 Castelnuovo Rangone
(MODENA) ITALY
Tel. +39 059 5330611 - Fax +39 059 537259
info@muratoriequip.it - www.muratoriequip.it

